



ELSEVIER

Contents lists available at [SciVerse ScienceDirect](http://www.sciencedirect.com)

Optics Communications

journal homepage: www.elsevier.com/locate/optcom

A tunable polymer waveguide ring filter fabricated with UV-based soft imprint technique

Linghua Wang^a, Xiuyou Han^{a,*}, Yiyang Gu^a, Yu Wang^a, Pin Zou^a, Jinyan Wang^b, Xigao Jian^b, Geert Morthier^c, Mingshan Zhao^a

^a School of Physics and Optoelectronic Engineering, Dalian University of Technology, 116023 Dalian, China

^b Department of Polymer Science and Materials, Dalian University of Technology 116023 Dalian, China

^c Photonics Research Group, INTEC-Department, Ghent University-IMEC, 9000 Ghent, Belgium

ARTICLE INFO

Article history:

Received 19 December 2012

Received in revised form

3 February 2013

Accepted 6 February 2013

Available online 28 February 2013

Keywords:

Polymer waveguide

Optical filter

Ring resonator

Soft imprint

ABSTRACT

Photonic integrated components with tunability, low power consumption and low fabrication cost are of considerable interest for optical communications and optical signal processing systems. Based on the high thermo-optic coefficient of polymer material, we demonstrate a tunable integrated waveguide ring filter with a novel but very simple UV-based soft imprint technique. By properly incorporating a Mach–Zehnder interferometer (MZI), the tunability of the ring filter's coupling states and resonant wavelength are realized flexibly by the micro-heaters. The tuning efficiency of resonant wavelength is 8.2 pm/mW within one free spectrum range of the ring filter.

© 2013 Elsevier B.V. All rights reserved.

1. Introduction

Photonic integration has been widely adopted for optical communication, signal processing and optical sensors because it can help significantly reduce the power consumption, cost and size of the system while enhancing its reliability and functionality [1–3]. As a basic photonic integrated component, the ring resonator plays an important role for the realization of different optical functions such as filtering, modulation, and switching. Ring resonator-based devices with high performance have been designed and demonstrated on different material platforms, e.g. glass, silica, silicon-on-insulator (SOI) or polymer [4,5]. Among them, polymer-based ring resonator devices, for example filters, modulators and reflectors [6–10], have been attracting more and more attention because of their advantages of low cost, good performance and potential for hybrid integration with other devices in inorganic or organic materials [11,12].

Polymer waveguide ring resonators with notch and bandpass filtering functions and their relevant application have been reported in References [6,10]. For the notch filter consisting of one ring coupled to one bus waveguide, in order to achieve a high notch depth, the critical coupling condition is usually required [13]. It means that the optical power coupled from the bus

waveguide into the ring should be equal with the round trip loss of the ring itself. However, this condition cannot be achieved easily due to the possible deviation between the designed and fabricated devices. Therefore, it increases the complexity and difficulty of device design and fabrication. If the coupling coefficient or the round trip loss (gain) could be tuned, for example, with a tunable coupler instead of the fixed directional coupler or with an optical amplifier inserted in the ring, the notch filtering function would be obtained conveniently [14–16].

In this paper, a tunable coupler with a Mach–Zehnder interferometer (MZI) is brought into the structure of a ring resonator. The high thermal-optical (TO) coefficient of the polymer is utilized to tune the equivalent MZI coupler with low power consumption. Different states of coupling condition, namely, over-, critical- and under-coupling, are realized. At the same time, the tunability of resonant wavelengths is realized with the TO phase shifter on the polymer waveguide ring. The tunable polymer ring resonator has potential applications for microwave photonic filter, optical switching and optical true time delay.

2. Material

In our work, a silicate based inorganic–organic hybrid optical material named as polysiloxane-liquid series (PSQ-Ls), which is developed in our group, is chosen for the fabrication of waveguide devices [17]. Its two components, PSQ-LH and PSQ-LL, have

* Corresponding author. Tel.: +86 411 84706492.

E-mail address: xyhan@dlut.edu.cn (X. Han).

refractive index values of 1.515 and 1.454 at 1550 nm, low optical loss and high thermal stability, which can be used as waveguide core and cladding, respectively [18]. The unique solvent-free property and good UV curable property make it highly compatible with our developed UV-based soft imprint technique [19].

3. Design and simulation

Fig. 1 shows the schematic picture for the structure of the proposed tunable polymer ring resonator. The layout design for the device is shown in Fig. 1(a). A MZI consisting of two 3 dB directional couplers is used as the equivalent tunable coupler for the ring resonator, while the ring resonator itself is constructed by connecting one output port of MZI to one of its input ports. The lengths of the two arms of MZI are equal. One micro-heater is placed on one of them. The change of the phase relationship between two arms through TO effect can result in a difference of the optical power which is coupled into the ring resonator, thus achieving the tunability of the coupling efficiency. Another micro-heater is placed on the ring waveguide. The resonant wavelength position control can be realized with this phase shifter. The details of the dimension for this structure are as follows: the length of the MZI arm $L_1=1000\ \mu\text{m}$, the coupling length of the 3 dB directional coupler $L_2=58\ \mu\text{m}$ and the gap between the waveguides $d_1=1\ \mu\text{m}$. The bend radius of the ring resonator $R_1=500\ \mu\text{m}$. Several quasi-S bend waveguides are used to connect the 3 dB directional couplers with the input ports, output ports and the half circle bend waveguides. Their bend angles ϕ are designed to be 12° and bend radius R_2 to be $1400\ \mu\text{m}$. The length and width of the micro-heater on the ring resonator are $2000\ \mu\text{m}$ and $10\ \mu\text{m}$, while that on the MZI arm are $1000\ \mu\text{m}$ and $5\ \mu\text{m}$, respectively.

The cross section of the polymer waveguide loaded with micro-heater is shown in Fig. 1(b). To prevent extra substrate leakage loss, the thickness of the under cladding layer h_l is chosen to be $6\ \mu\text{m}$. The single mode condition of the polymer waveguide can be guaranteed by selecting the waveguide width w to be $2.5\ \mu\text{m}$ and height h_c to be $2.1\ \mu\text{m}$. With such waveguide dimensions, the bending loss of the curved waveguides can be negligible. In our current design, there is an extra layer (SU-8 polymer in experiment) with a thickness of around $1\ \mu\text{m}$ on top of the waveguide's upper cladding. It is used to protect the waveguide layer during the later lift-off process and this will be further explained in the Section 4. Although its refractive index of 1.57 is a little bit higher than that of the waveguide core, according to our simulation, if the thickness of the upper cladding between the waveguide core and the layer h_u can be controlled appropriately, the extra radiation loss of the waveguide mode caused by this layer can be neglected. The simulation result is shown in Fig. 2. The device is designed to be working in the TE mode, as its loss is much lower than that of the TM mode with a radius of $500\ \mu\text{m}$. In this work, the thickness of the upper cladding is chosen to be $2.8\ \mu\text{m}$. Further increasing such thickness can hardly decrease the radiation loss but lower the power efficiency of the micro-heater [20].

4. Fabrication of the device

A simple UV-based soft imprint method was adopted in our work to fabricate polymer waveguide structures. Such a transformed soft lithography method has been proved to be a cost- and throughput-efficient way for patterning not only the photo resist but also the polymer waveguides straightforwardly [19,21]. Especially for the waveguide devices fabrication, the simple UV

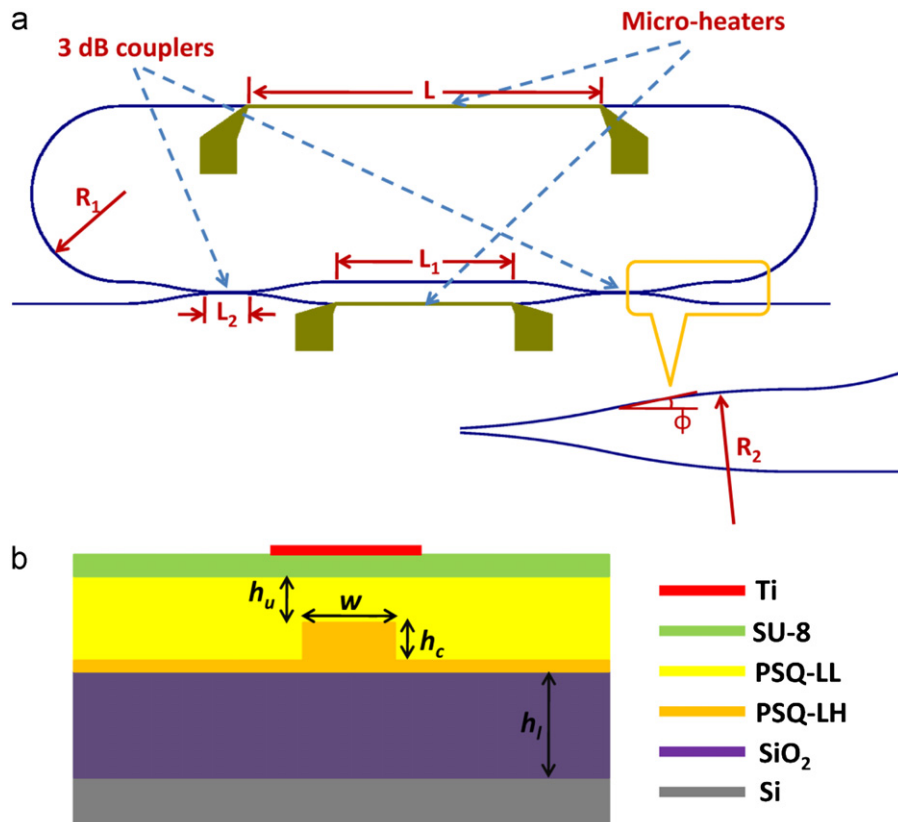

Fig. 1. The schematic picture for the structure of the proposed tunable polymer ring resonator. (a) The device layout design and (b) The waveguide cross section with micro-heater.

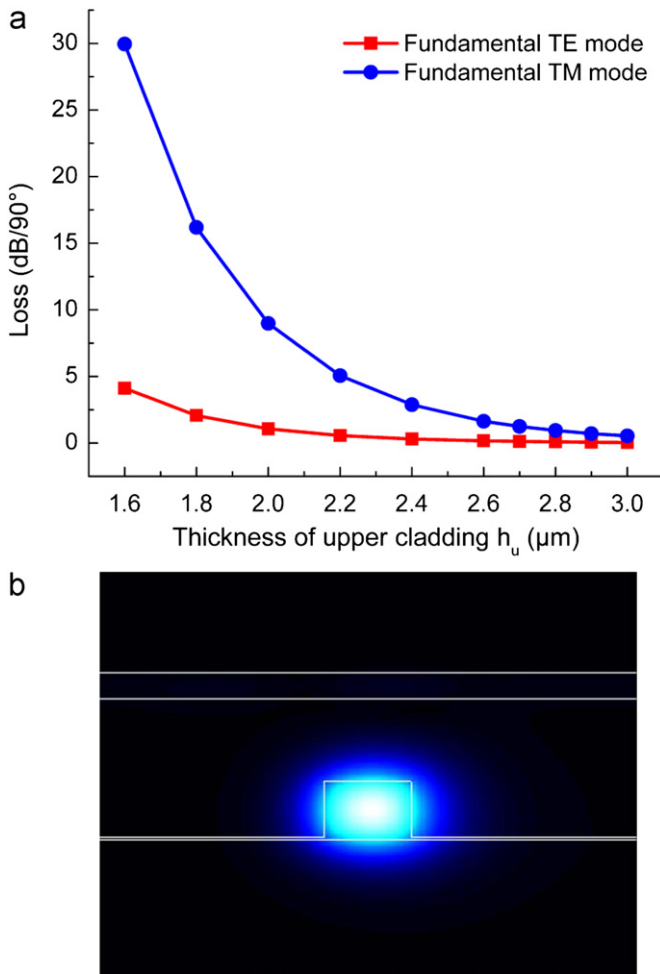

Fig. 2. (a) The relationship between the bend loss of the fundamental waveguide mode and the thickness of the polymer upper cladding and (b) The fundamental TE mode of the designed waveguide with a bend radius of 500 μm.

imprinting technique makes good use of the plastic property of polymer material, which avoids the complicated multi-steps of the CMOS process, such as lithography, metal mask fabrication and dry etching. As a result, it reduces the fabrication time and cost efficiently.

The detailed fabrication process is shown from step 1 to step 5 in Fig. 3. First, a SiO₂ layer with a thickness of 6 μm is deposited on top of the silicon substrate by plasma-enhanced chemical vapor deposition (PECVD), which acts as the under cladding of the waveguide. Secondly, a thin layer of PSQ-LH is spin-coated on top of it, followed by the imprinting of the soft PDMS mold upon this layer. The mold is replicated from a master mold using the casting method. When the PSQ-LH layer becomes solidified after UV exposure, the PDMS mold is peeled off. Because of the good UV curing property of PSQ-Ls material and its solvent-free characteristic, the waveguide structures can be transferred from the PDMS mold to the PSQ-LH layer with this one step imprinting, dramatically reducing the fabrication time and cost. Besides that, the waveguide quality can be further optimized by methods such as the thermal reflow technique [22], which helps reduce the propagation loss of the polymer waveguide. The sample is then baked for 2 h at a temperature of 180 °C to fully cure the waveguide core layer. PSQ-LL layer of around 4.9 μm is used as upper cladding.

For the fabrication of the micro-heaters, although photo lithography and dry etching are widely used, such a process will

counteract the benefits brought by the UV imprinting process, which is rather simple and of low cost. Compared with that, the lift-off process has been proved to be an ideal alternative for the fabrication of the micro-heaters [23]. In our work, in order to take advantage of this process, a thin SU-8 protecting layer with a thickness of 1 μm is added on top of the upper cladding. By experiment, it was found not only to have good adhesion with the deposited metal, but more importantly, it is quite stable during the whole process of lift-off, protecting the already fabricated waveguide's structures underneath from the attack of different solvents. These processes are shown from step 6 to step 10 in Fig. 3. The pattern definition for the micro-heaters was achieved with the positive photo resist AZ5214 (MicroChemicals), after which titanium with a thickness of 110 nm was sputtered. The metal lift-off process was finally realized by immersing the sample into acetone for 1 h. As can be seen, the fabrication process, including both the waveguide fabrication and the micro-heaters' definition, is very simple, of low cost and suitable for mass production. The microscope image of the final fabricated devices is shown in Fig. 4.

5. Measurement results

The measurement setup is shown in Fig. 5. The electric power is loaded onto the fabricated device through four micro-needles, the head size of which is 12 μm. In order to measure the transmission of the device, the light from a tunable laser is launched into the input waveguide via a lensed fiber. Its polarization state is carefully tuned to TE with a polarization controller to prevent extra loss, as predicted by the simulation. The output light is collected by a cleaved single-mode fiber, which is connected to a power meter.

The resistance of two micro-heaters, one on the arm of MZI and the other on ring resonator, is first obtained by measuring their voltage–current relationship. The results are shown in Fig. 6. With linear fitting, resistance value of 2.4471 kΩ for the MZI micro-heater and that of 2.5674 kΩ for the micro-heater of the ring resonator can be estimated. Due to its length, the latter is a little bit larger than the former, although it has a larger width.

Different coupling states are realized by applying the electric power only to the micro-heater on the MZI arm. The result is shown in Fig. 7. As can be seen, the extinction ratio of the filter can be tuned by the applied electric power, corresponding to the coupling coefficient of the MZI-based coupler. At first, the ring resonator is working under the state of over-coupling as most of the light in input waveguide is coupled into the ring resonator after passing the MZI. Although in theory there should be no resonance under zero applied electric power, a shallow dip around 1 dB is observed. This is because the two fabricated directional couplers constituting the MZI are not strictly 3 dB. The light coupled into the ring resonator is decreased with the applied power. When this coupled energy equals with the roundtrip loss of the ring, e.g. critical coupling condition [13] is met, the highest extinction ratio (~11.5 dB) and narrowest bandwidth (~0.0163 nm) of the filter are obtained. The Q factor of the device under such state can thus be estimated to be around 9.5×10^4 . The result for such a high Q factor can be partly attributed to the low propagation loss of the fabricated polymer waveguide, which is around 1.7 dB/cm for TE mode. The continued increasing electric power will make the ring working under under-coupling state. The tunability of coupling states can be utilized to achieve the switch function. Compared with other kinds of thermo-optics device (e.g. optical switch in Ref. [24]), the power consumption for our device to obtain high extinction ratio of the transmitted light is much lower if the working wavelength is chosen appropriately. Such benefit is brought by the resonant effect of the

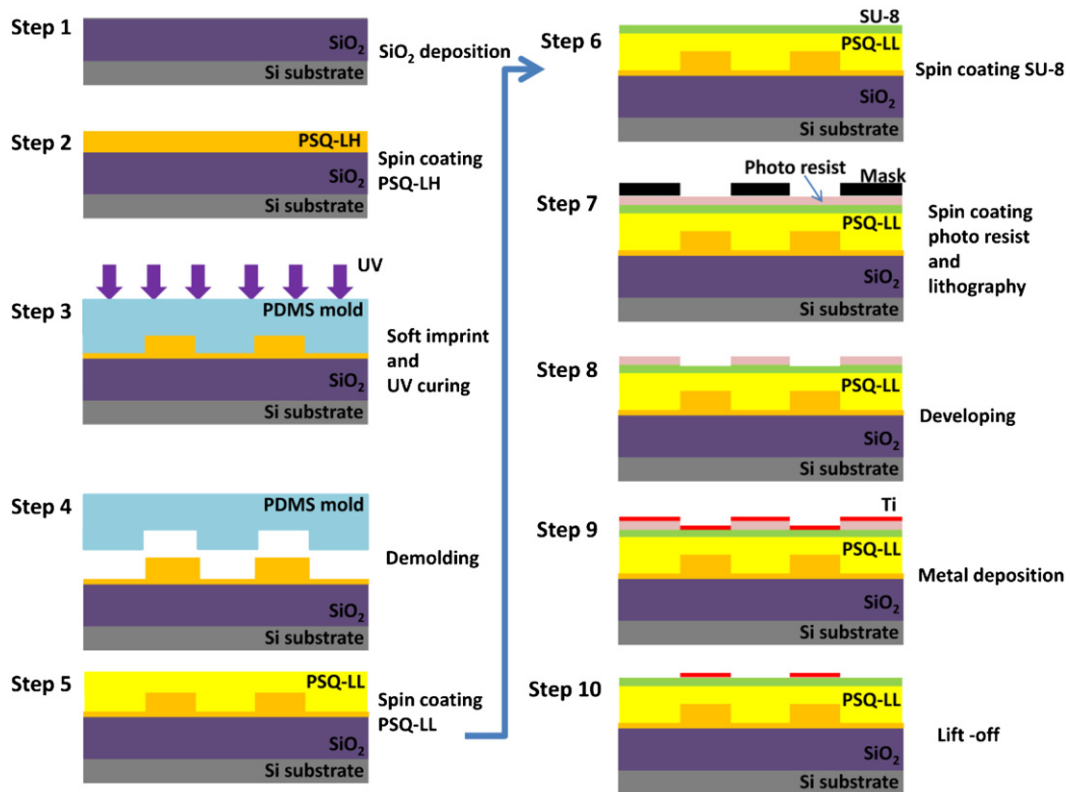

Fig. 3. The whole fabrication process for the polymer-based tunable ring resonator. The UV-based soft imprint technique is illustrated from step 1 to step 5. The lift-off process for the fabrication of micro-heaters is illustrated from step 6 to step 10.

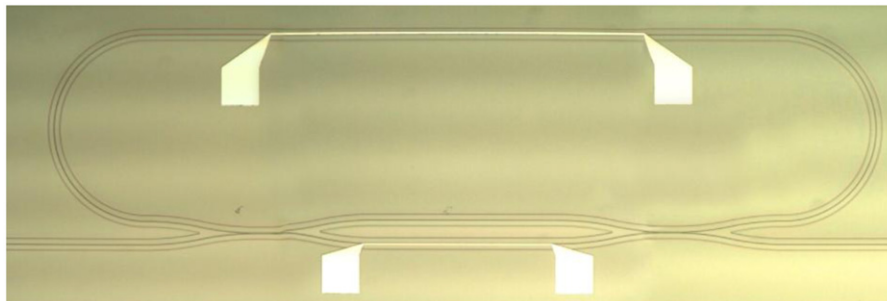

Fig. 4. The microscope image of the fabricated device, including polymer waveguide and the loaded micro-heaters.

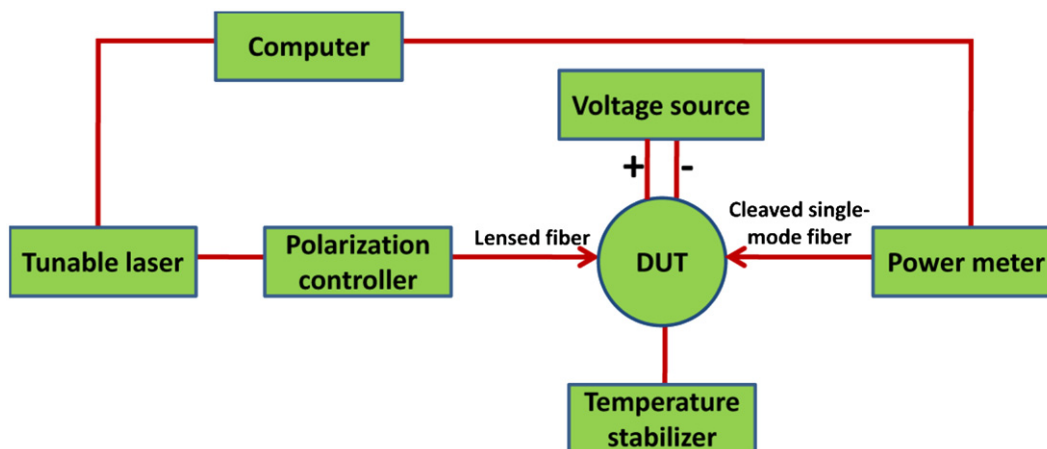

Fig. 5. The scheme of the measurement setup.

ring resonator. It is also noted that such effective coupling state tuning during this process generates an additional phase shift to the ring resonator, which results in a small resonant wavelength shift [25]. When the ring resonator is used as a filter, the small resonant wavelength shift should be compensated with the micro-heater on the ring waveguide.

The resonant wavelength of the fabricated polymer waveguide ring filter can also be tuned. This is realized by applying the electric power to the micro-heater on the ring waveguide. The power applied on the micro-heater of the arm of MZI should be kept at the value where desired bandwidth and extinction ratio are achieved. Here it is demonstrated with the one that the critical coupling condition is met, which is 4.185 mW. As can be seen, the resonant wavelength can be tuned freely within one free spectrum range of the ring resonator, which is around 0.16 nm (~20 GHz), also with low power consumption. The resonant wavelength of the device decreases with higher electric power.

This can be explained by the shortening of the optical path of the ring waveguide when a part of it is heated up, due to the negative thermal-optical coefficient of PSQ-Ls waveguide. As shown in

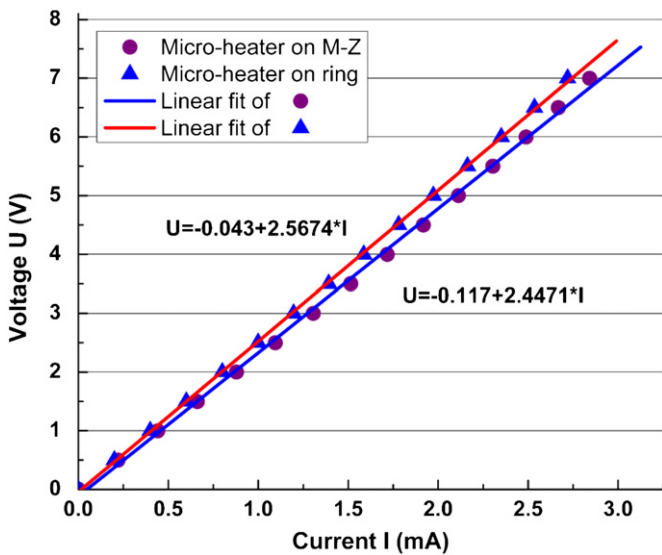

Fig. 6. The voltage–current relationship of the fabricated micro-heaters.

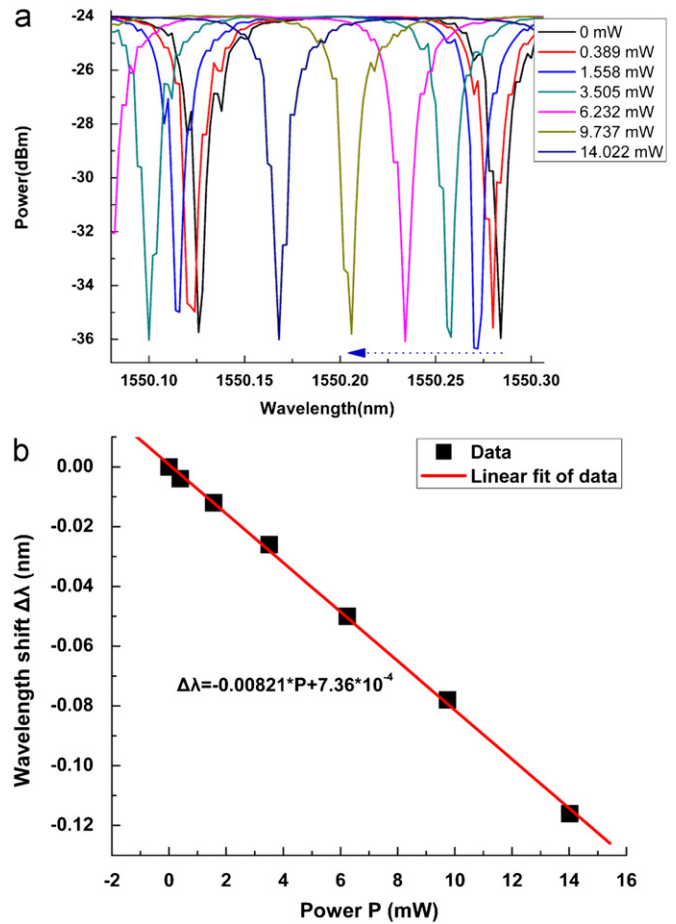

Fig. 8. The tuning of filtering wavelength of the fabricated polymer tunable ring resonator.

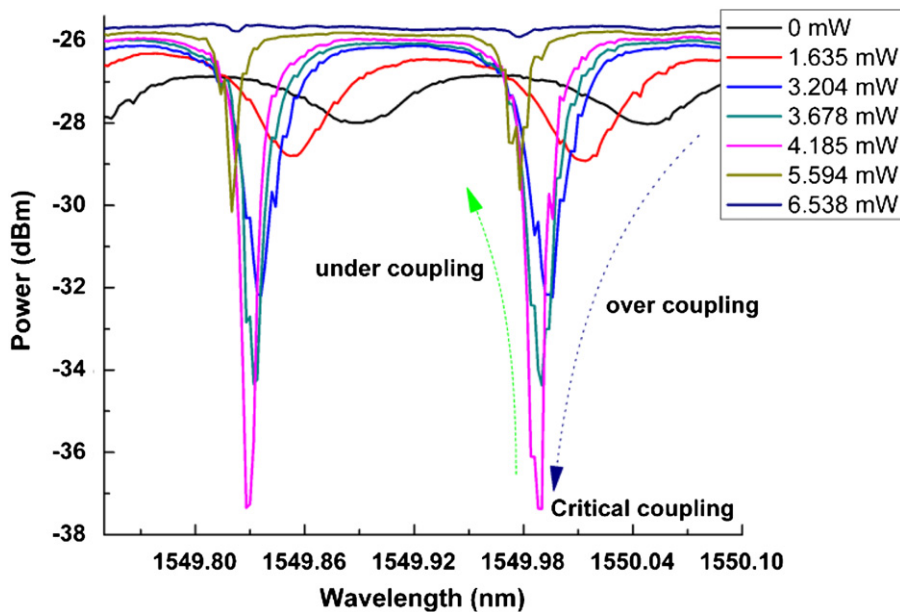

Fig. 7. The tuning of different coupling states of the fabricated polymer tunable ring resonator.

Fig. 8, the resonant wavelength shifts linearly with the applied power, and the tuning efficiency is about 8.2 pm/mW. According to request, flexible filtering performance can be realized by cascading such tunable ring resonators.

6. Conclusion

In this work, we propose and demonstrate a tunable ring resonator based on polymer material. Different from the traditional one, the device gives much more flexibility by incorporating a MZI and two micro-heaters. Not only can different coupling states be realized, but also the resonant wavelength can be tuned easily, both with low power consumption. Moreover, the novel UV-based soft imprint technique has been adopted to fabricate the prototype device, which is compatible with the polymer property and has the advantages of low cost and high throughput. The device is expected to find useful applications in optical switching and optical filtering.

Acknowledgments

This work was supported in part by the National Natural Science Foundation of China (Nos. 60807015, 61077015, and 60577014), the National High-tech R&D Program (No.2012AA040406), the Specialized Research Fund for the Doctoral Program of Higher Education (No. 200801411037), the Natural Science Foundation of Liaoning Province (No. 20102020) and the Fundamental Research Funds for the Central Universities.

References

- [1] D. Kim, J. Luo, Y. Tian, A.K. Jen, N. Peyghambarian, *Nature Photonics* 1 (2007) 180.
- [2] N. Bamiedakis, A. Hashim, R.V. Pentyl, I.H. White, *Optics Express* 20 (2012) 11625.
- [3] Xudong Fan, Ian M. White, Siyka I. Shopova, Hongying Zhu, Jonathan D. Suter, Yuze Sun, *Analytica Chimica Acta* 620 (2008) 8.
- [4] S. Otto, *Proceedings of the SPIE* 6872 (2008) 68720H.
- [5] Jesús Palací, Guillermo Eduardo Villanueva, Jose Vicente Galán, Javier Martí, Borja Vidal, *Photonics Technology Letters* 22 (2010) 1276.
- [6] Joyce K.S. Poon, Lin Zhu, Guy A. DeRose, J. Amnon Yariv, *Lightwave Technology* 24 (2006) 1843.
- [7] Gun-Duk Kim, Sang-Shin Lee, *Optics Communications* 278 (2007) 303.
- [8] Bartosz Bortnik, Yu-Chueh Hung, Hidehisa Tazawa, Byoung-Joon Seo, Jingdong Luo, K.-Y. Jen, William H. Steier, Harold R. Fetterman, *Journal of Selected Topics in Quantum Electronics* 13 (2007) 104.
- [9] Joonoh Park, Taehyung Lee, Donghyun Lee, Suhyun Kim, Woonglin Hwang, Youngchul Chung, *Photonics Technology Letters* 20 (2008) 988.
- [10] Xiuyou Han, Jianing Zhang, Linghua Wang, Yiyang Gu, Meng Wang, Jie Teng, Jinyan Wang, Xigao Jian, Geert Morthier, Mingshan Zhao, *Optical Engineering* 50 (2011) 124601.
- [11] Hong Ma, Alex K.-Y. Jen, Larry R. Dalton, *Advanced Materials* 14 (2002) 1339.
- [12] Nan Jokerst, Matthew Royal, Sabarni Palit, Lin Luan, Sulochana Dhar, Talmage TylerChip, *Journal of Biophotonics* 2 (2009) 212.
- [13] A. Yariv, *Electronics Letters* 36 (2000) 321.
- [14] Xiao-Yang Zhang, Tong Zhang, Xiao-Jun Xue, Jin-Ling Zhang, Jun Hong, Peng-Qin Wu, Qiu-Yue Chen, *Journal of Lightwave Technology* 28 (2010) 2512.
- [15] Jin Yao, David Leuener, Ming-Chang M. Lee, Ming C. Wu, *Journal of Selected Topics in Quantum Electronics* 13 (2007) 202.
- [16] V.M. Menon, W. Tong, S.R. Forrest, *Photonics Technology Letters* 16 (2004) 1343.
- [17] Hongbo Zhang, Jinyan Wang, Linke Li, Yuan Song, Mingshan Zhao, Xigao Jian, *Thin Solid Films* 517 (2008) 857.
- [18] Xiuyou Han, Linghua Wang, Yuhui Liu, Hongbo Zhang, Jinyan Wang, Xigao Jian, Mingshan Zhao, *Proceedings of the SPIE* 7134 (2008) 713416.
- [19] Jie Teng, Stijn Scheerlinck, Hongbo Zhang, Xigao Jian, Geert Morthier, Roel Beats, Xiuyou Han, Mingshan Zhao, *Photonics Technology Letters* 21 (2009) 1323.
- [20] Hongyan Song, Xiuyou Han, Pin Zou, Linghua Wang, Yiyang Gu, Jinyan Wang, Xigao Jian, Mingshan Zhao, *Acta Optica Sinica* 32 (2012) 0723003.
- [21] L.J. Guo, *Advanced Materials* 19 (2007) 495.
- [22] C.Y. Chao, W. Fung, L.J. Guo, *IEEE Journal of Selected Topics in Quantum Electronics* 12 (2006) 134.
- [23] Matteo Caloon, Aminul Islam, Hans N. Hansen, Christian Ravn, *International Journal of Advanced Manufacturing Technology* 59 (2012) 101.
- [24] Nan Xie, Takafumi Hashimoto, Katsuyuki Utaka, *Photonics Technology Letters* 21 (2009) 1335.
- [25] Jianing Zhang, Xiuyou Han, Hongyan Song, Jie Teng, Pengsheng Wu, Linghua Wang, Mingshan Zhao, *Acta Optica Sinica* 30 (2010) 2098.