



Fabricage van nanofotonische structuren met gefocusseerde ionenbundels

publieke verdediging
Jonathan Schrauwen

Promotor: Prof. Dries Van Thourhout

Vakgroep Informatietechnologie
Faculteit Ingenieurswetenschappen

4 februari 2009

Licht

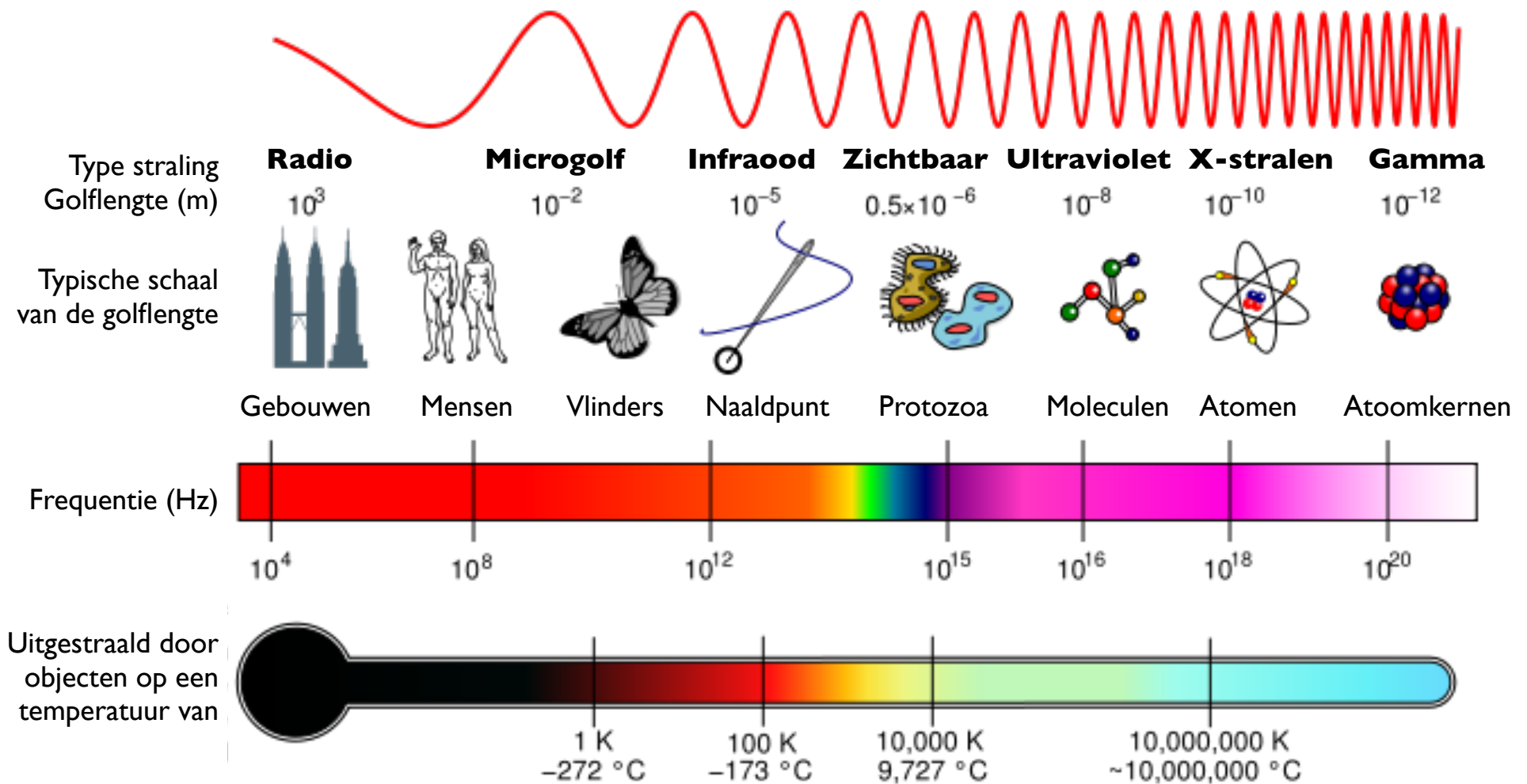

Golven of deeltjes?

$$\nabla \cdot \vec{E} = \frac{\rho}{\epsilon_0} = 4\pi k \rho$$

$$\nabla \cdot \vec{B} = 0$$

$$\nabla \times \vec{E} = -\frac{\partial \vec{B}}{\partial t}$$

$$\nabla \times \vec{B} = \frac{\vec{J}}{\epsilon_0 c^2} + \frac{1}{c^2} \frac{\partial \vec{E}}{\partial t}$$

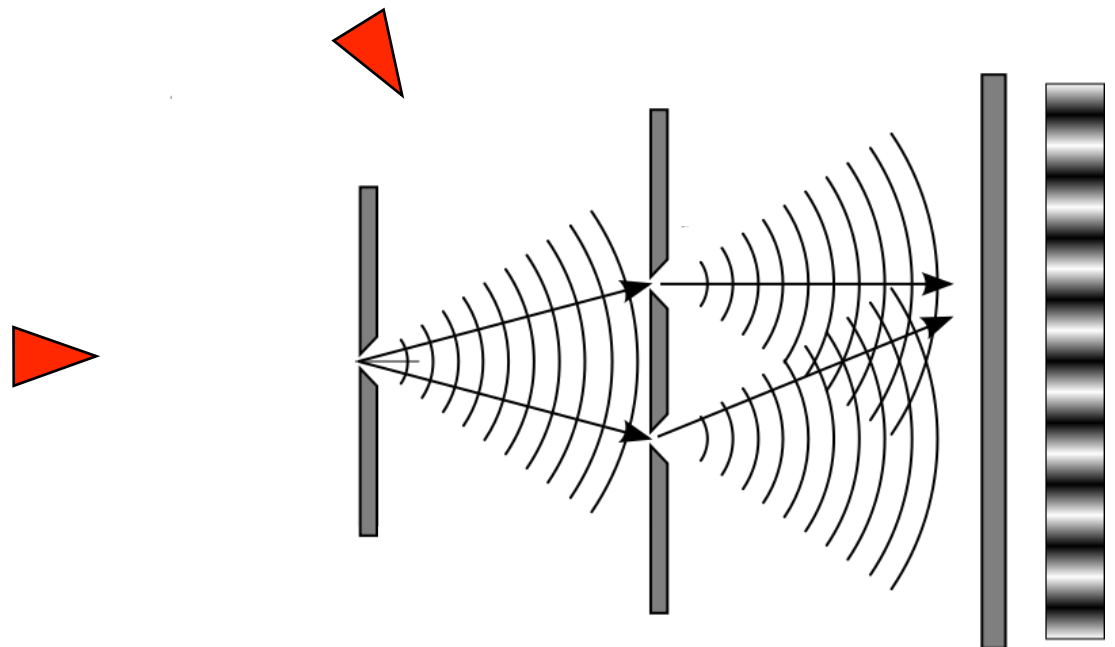
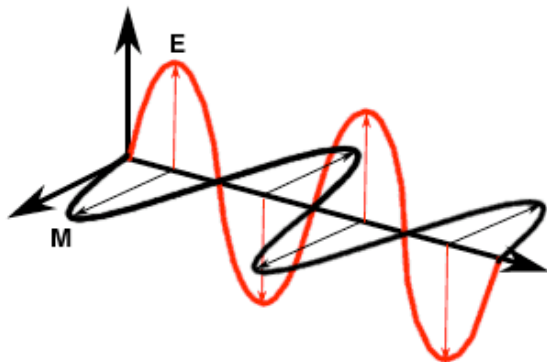

Golven of deeltjes?

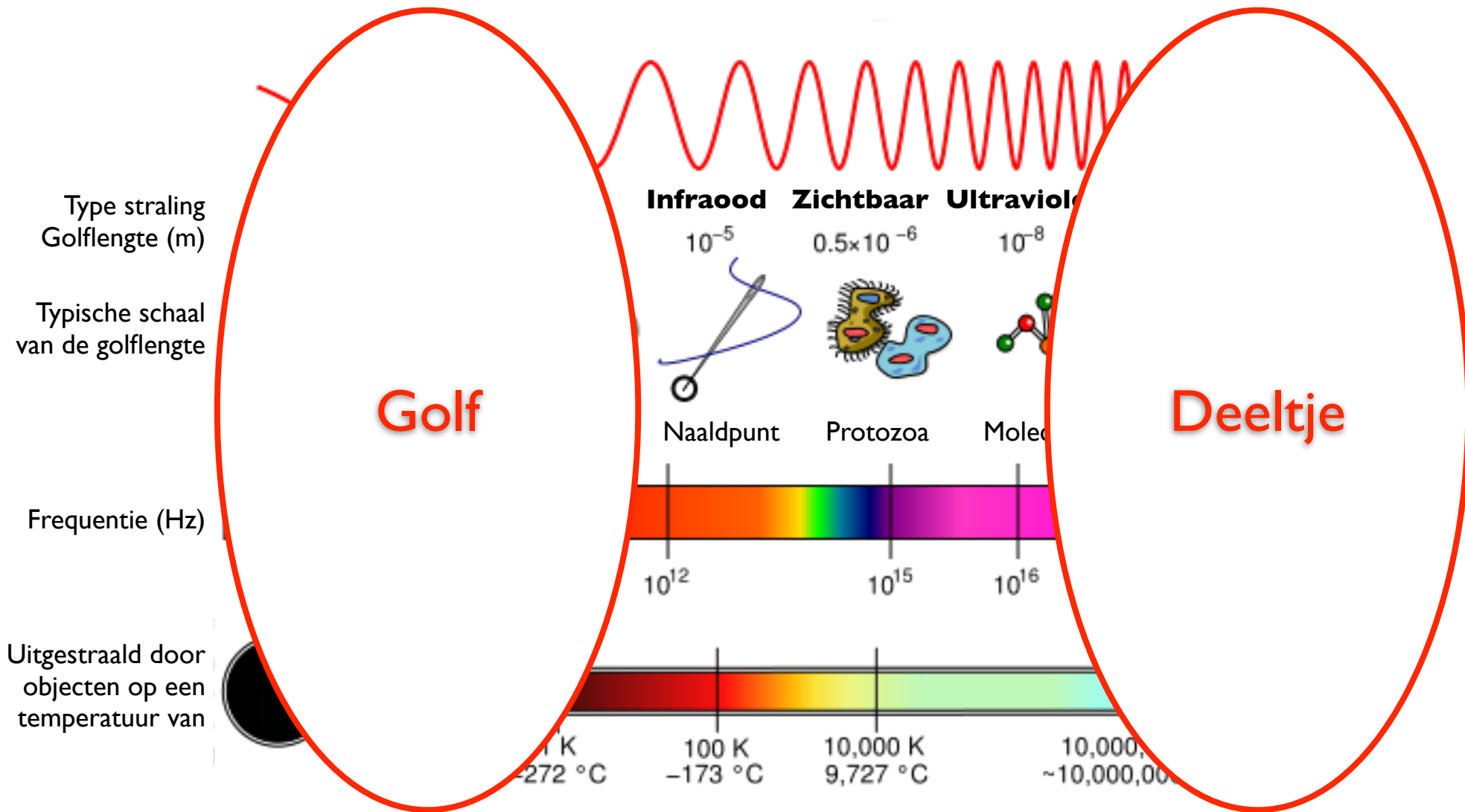

Lichtbreking

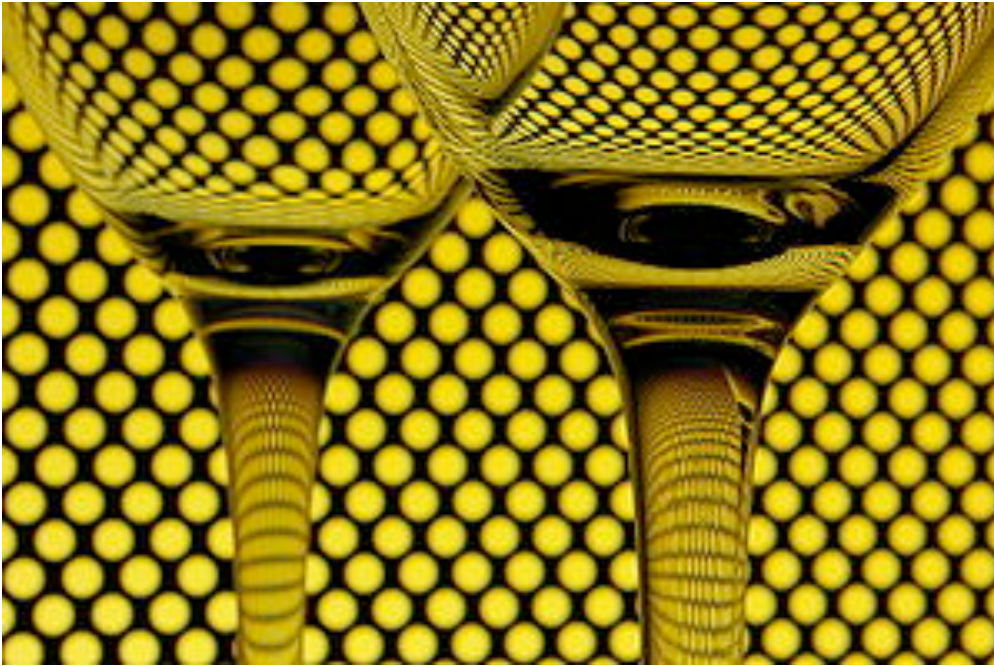

verschil in brekingsindex (Δn) \uparrow



brekingshoek \uparrow

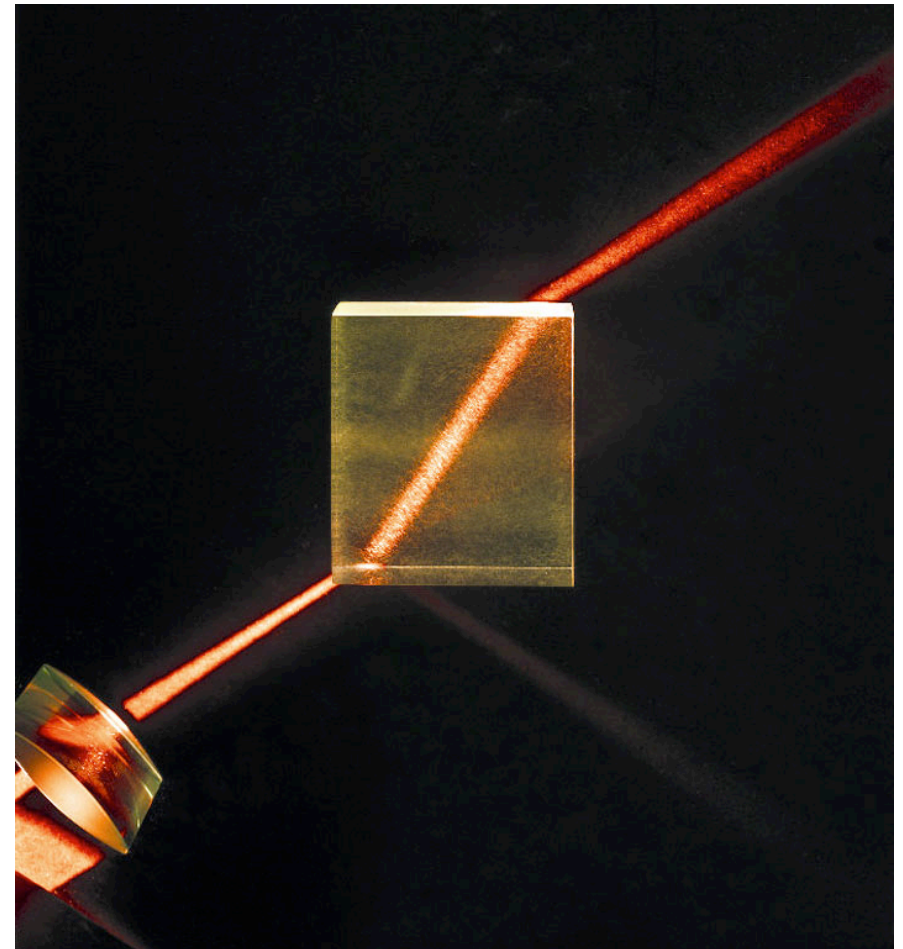

Totale interne reflectie

Principe

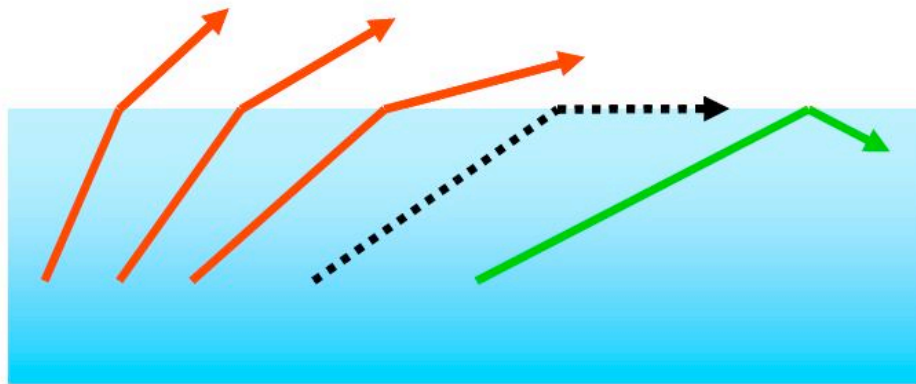

verschil in brekingsindex (Δn) \uparrow



TIR hoek \uparrow

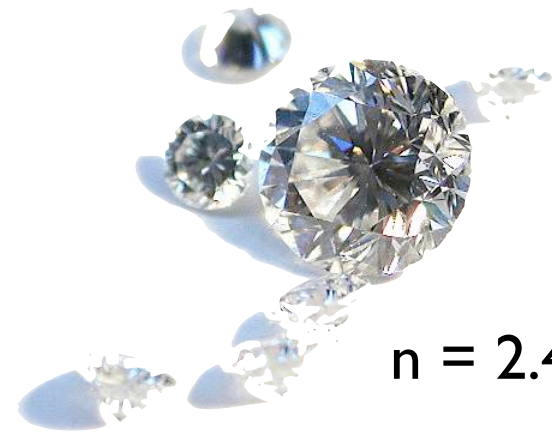

$n = 1.5$

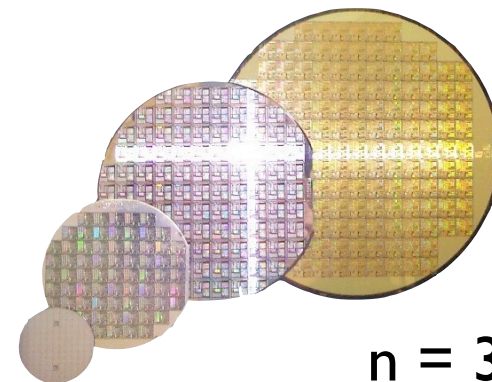

$n = 2.4$



$n = 3.5$

Lichtgeleiding in vezels en chips

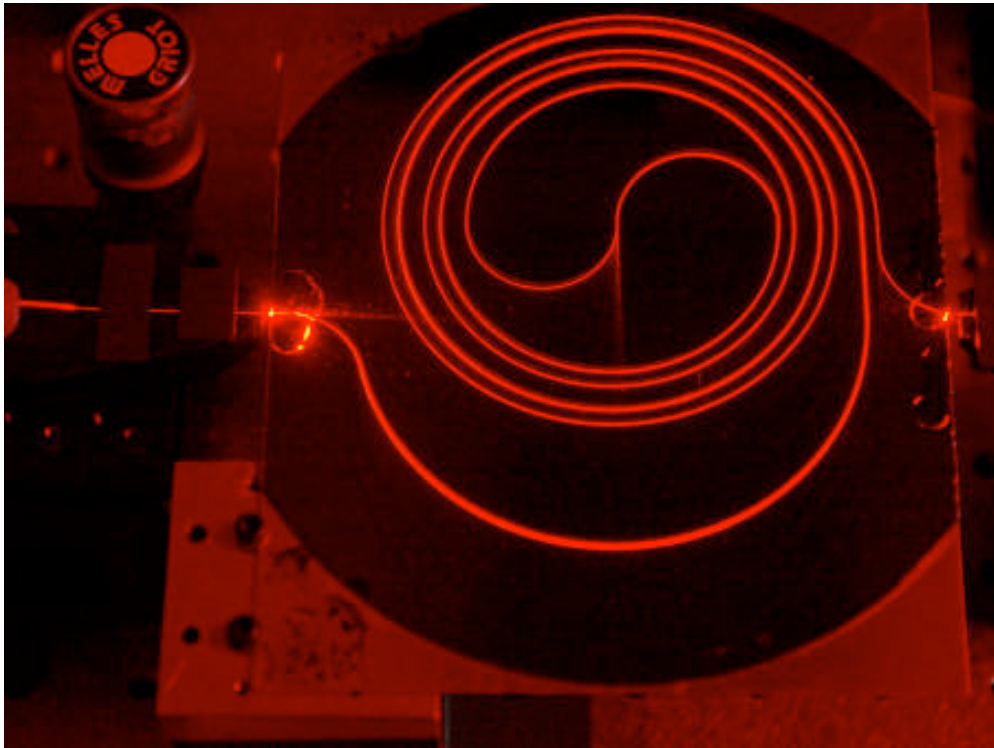

verschil in brekingsindex (Δn) \uparrow \blacktriangleright Minimale bochtstraal \downarrow

Communicatie over vezel

00101010101001000111111010000



50 Mbps
1 DVD per 15 min
afstand 100 m

00101010101001000111111010000



10 Gbps
1 DVD per 5 sec
afstand 100 km

00101010101001000111111010000

00101010101001000111111010000

00101010101001000111111010000

⋮

00101010101001000111111010000



multiplexing



> 10 Tbps = 1000 Gbps
> 1000 DVDs per 5 sec
afstand 100 km

Lichtgeleiding op chips

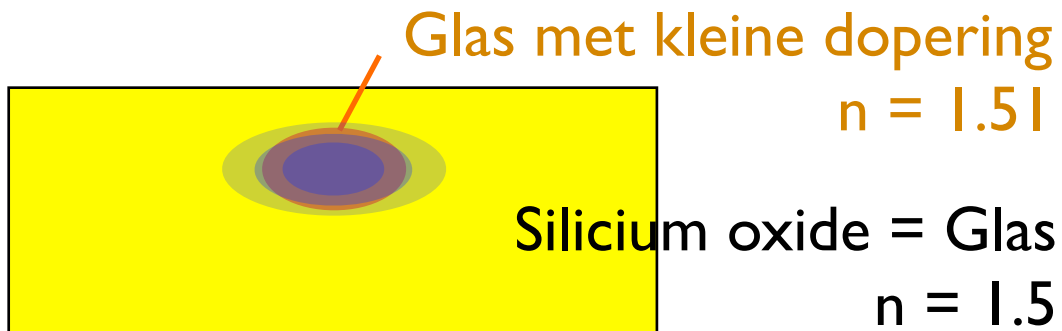

▶ Laag index contrast

▼
Grootte circuit = cm

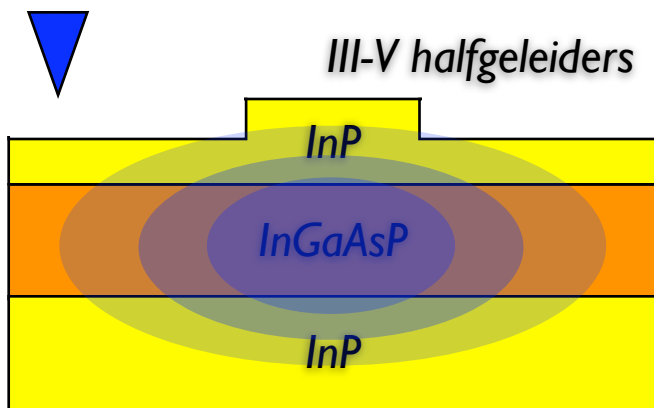

▶ Grootte circuit = mm

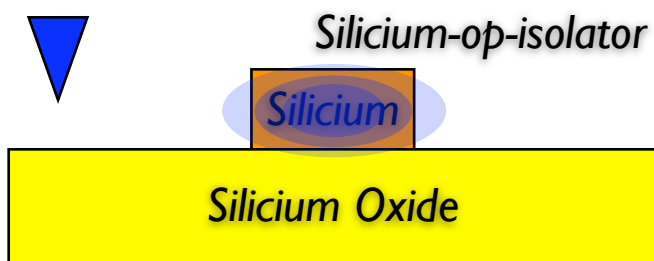

▶ Grootte circuit = 100 μm

▶ = meer functies
= goedkoper

Nanofotonische structuren?

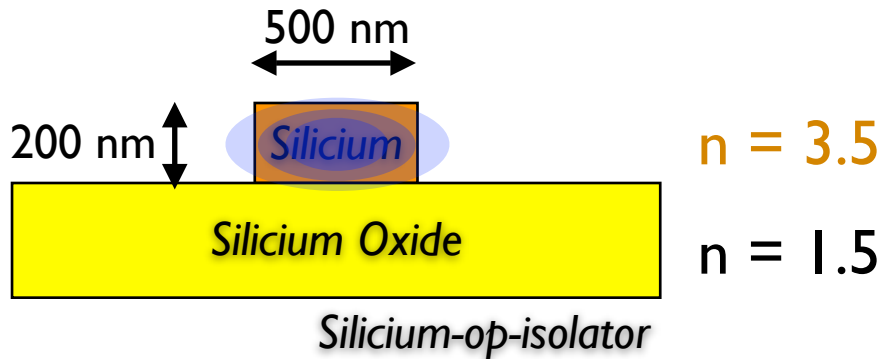

▶ Grootte circuit = 100 μm

Twee componenten in meer detail:

Roosterkoppelaar

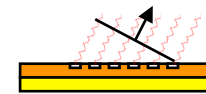

Ringresonator



Roosterkoppelaar

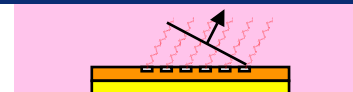
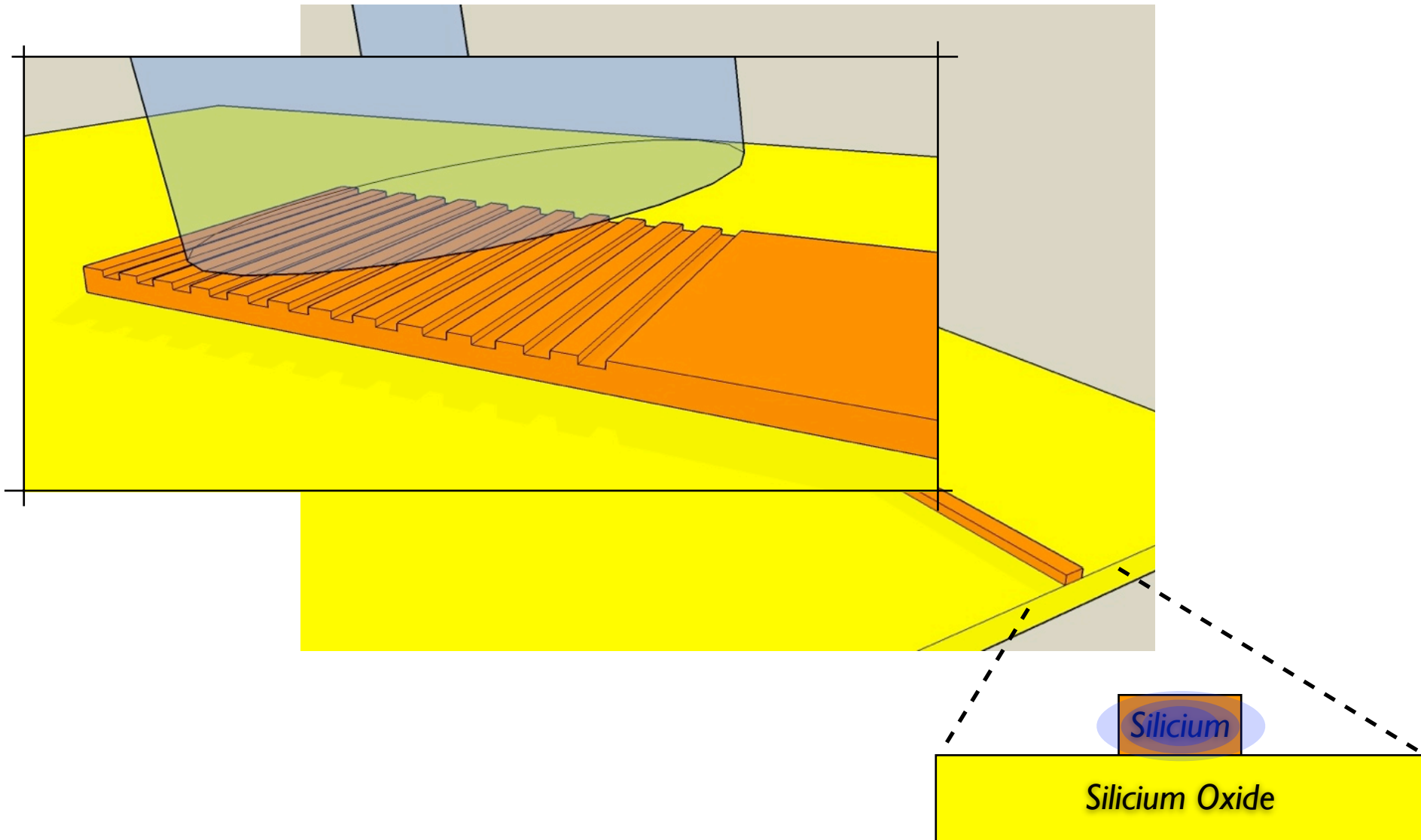

Roosterkoppelaar

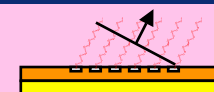
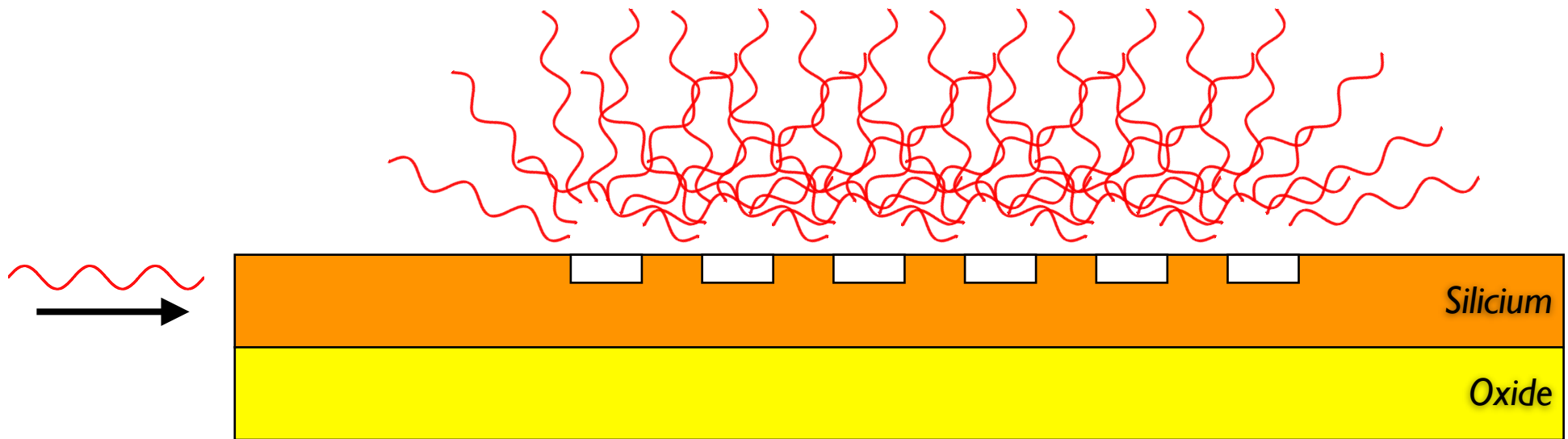

Roosterkoppelaar

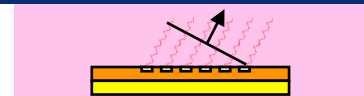
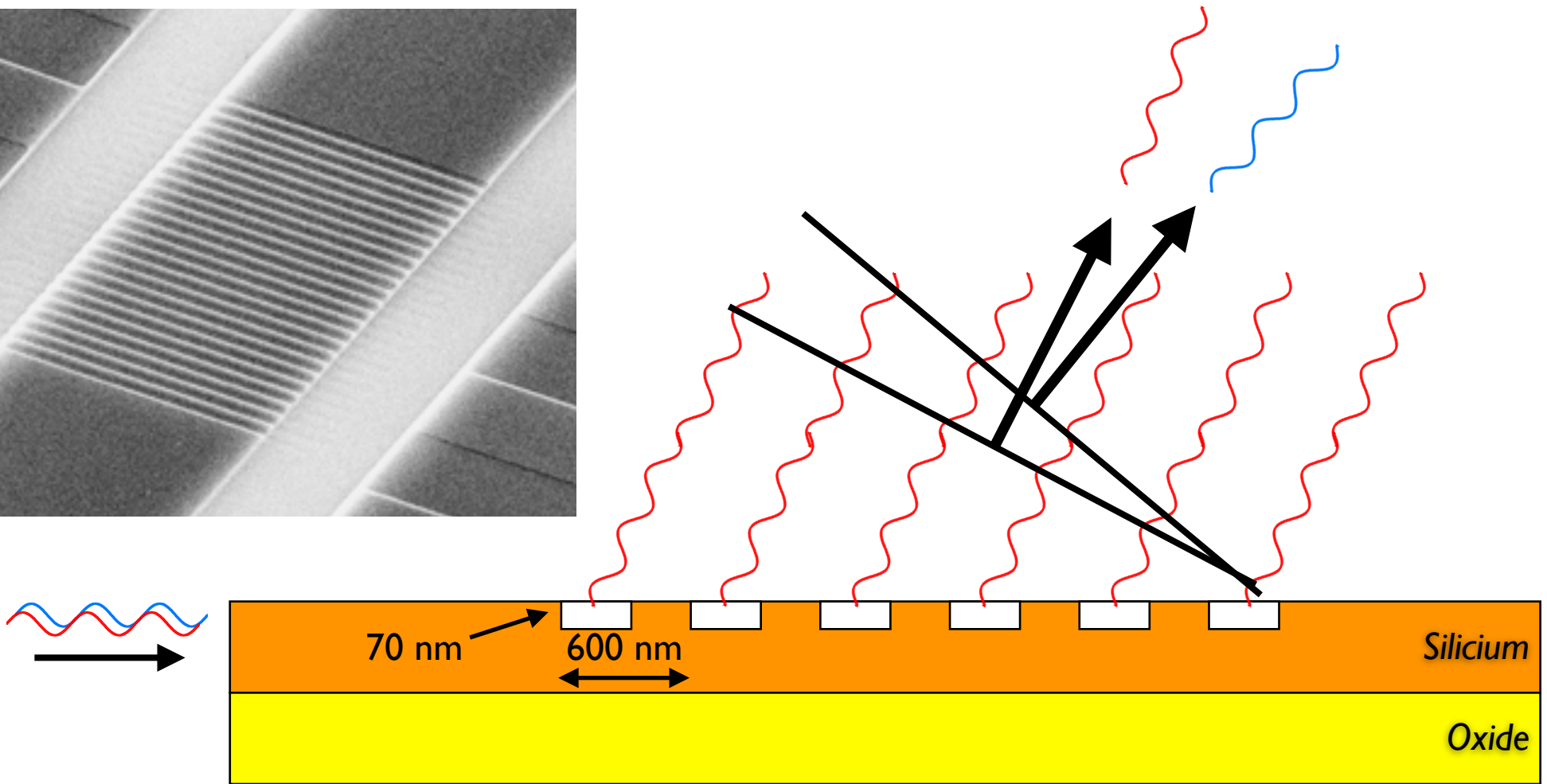
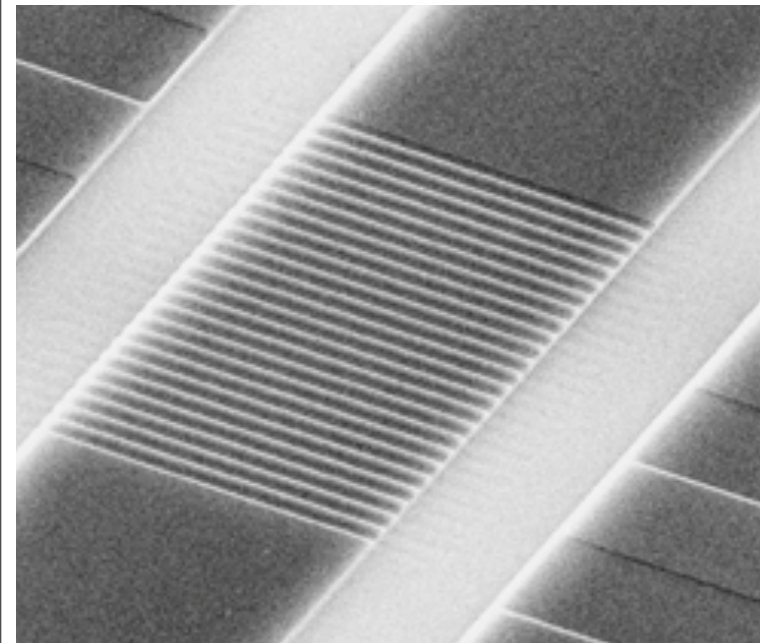

Ringresonator

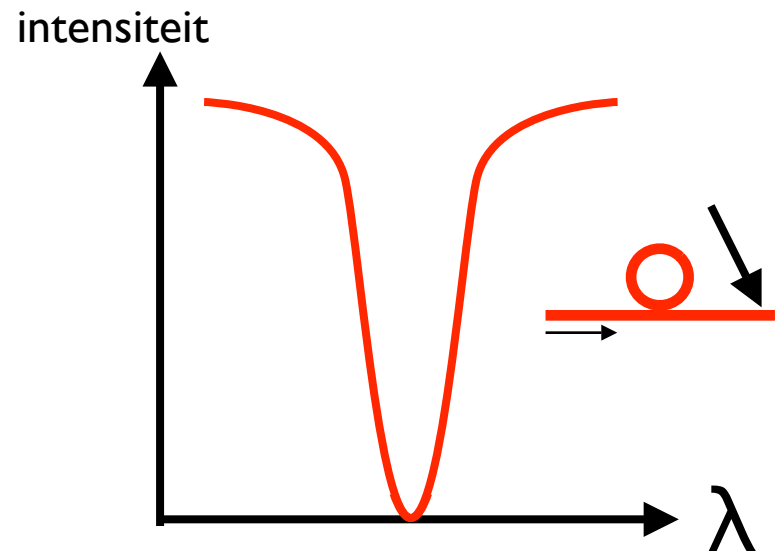
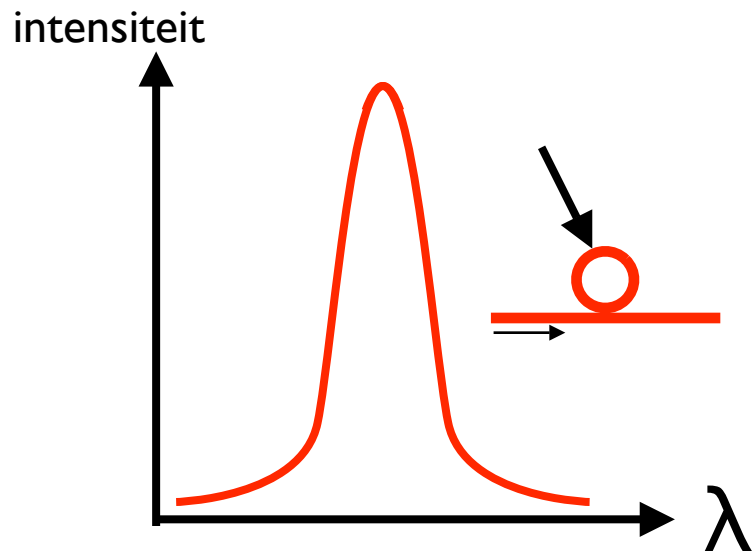
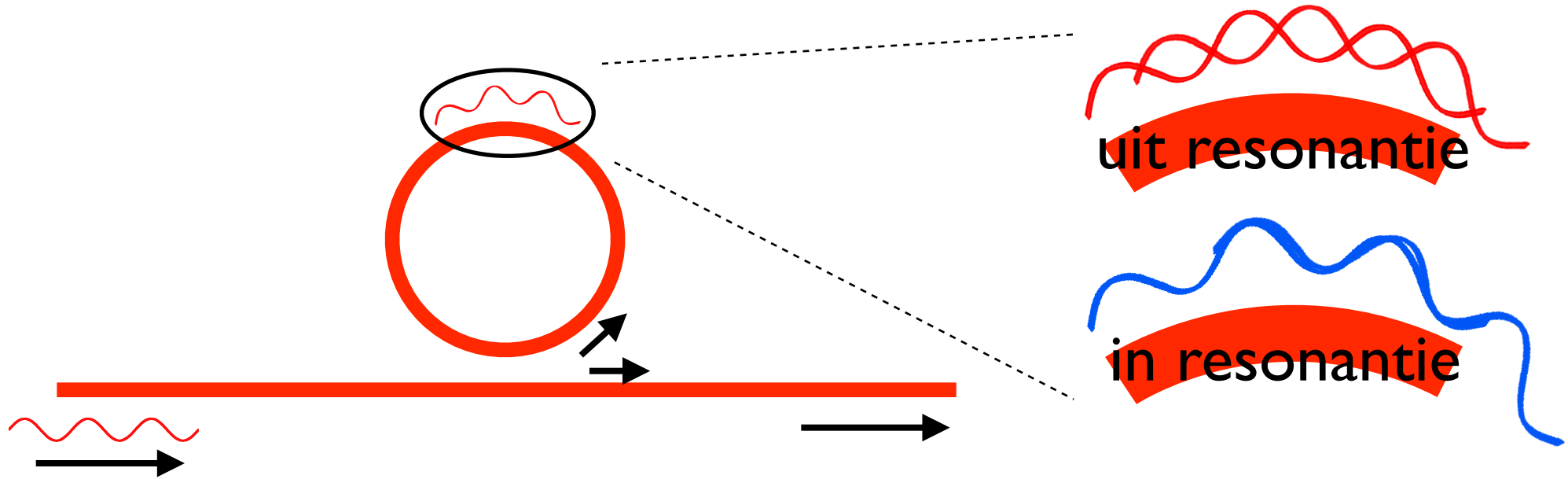

Ringresonatoren zijn filters

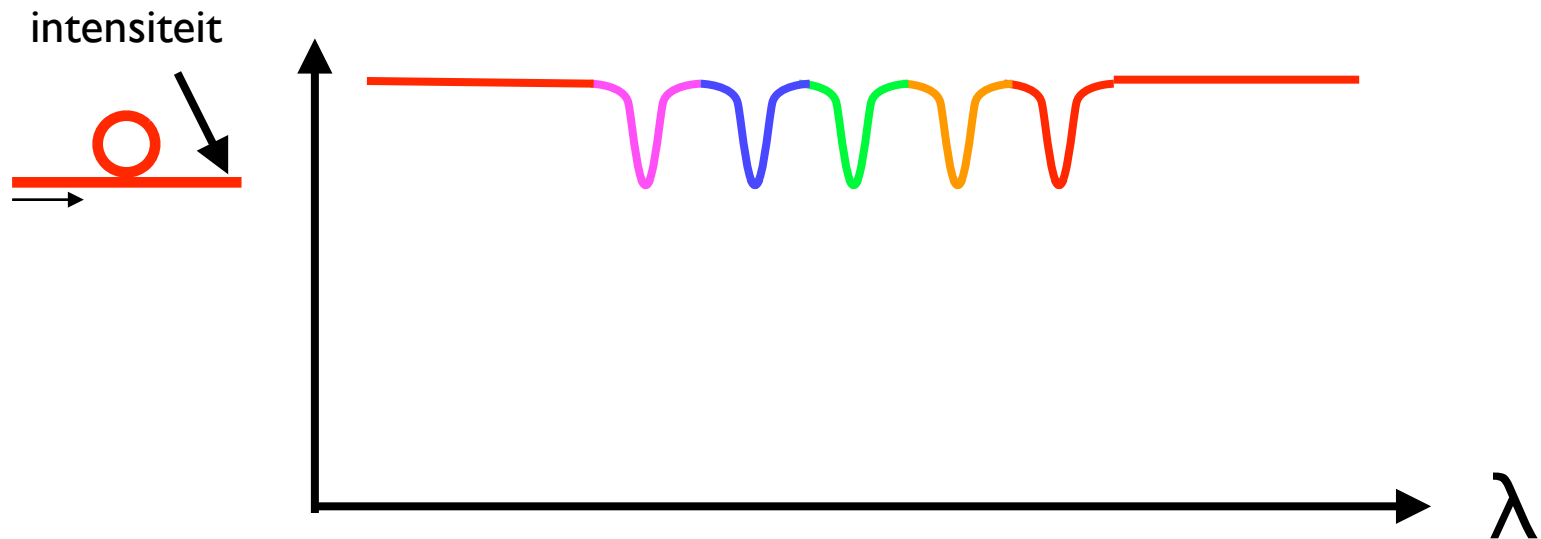
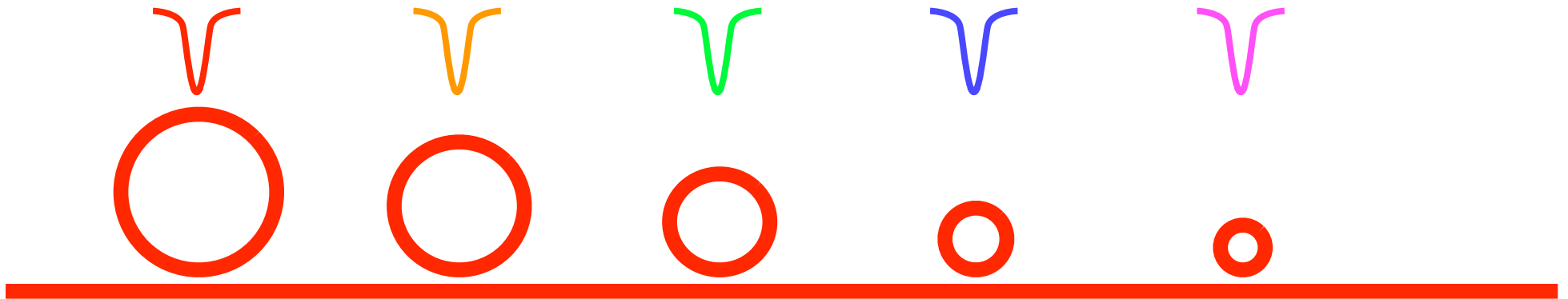

Golflengte (de)multiplexing

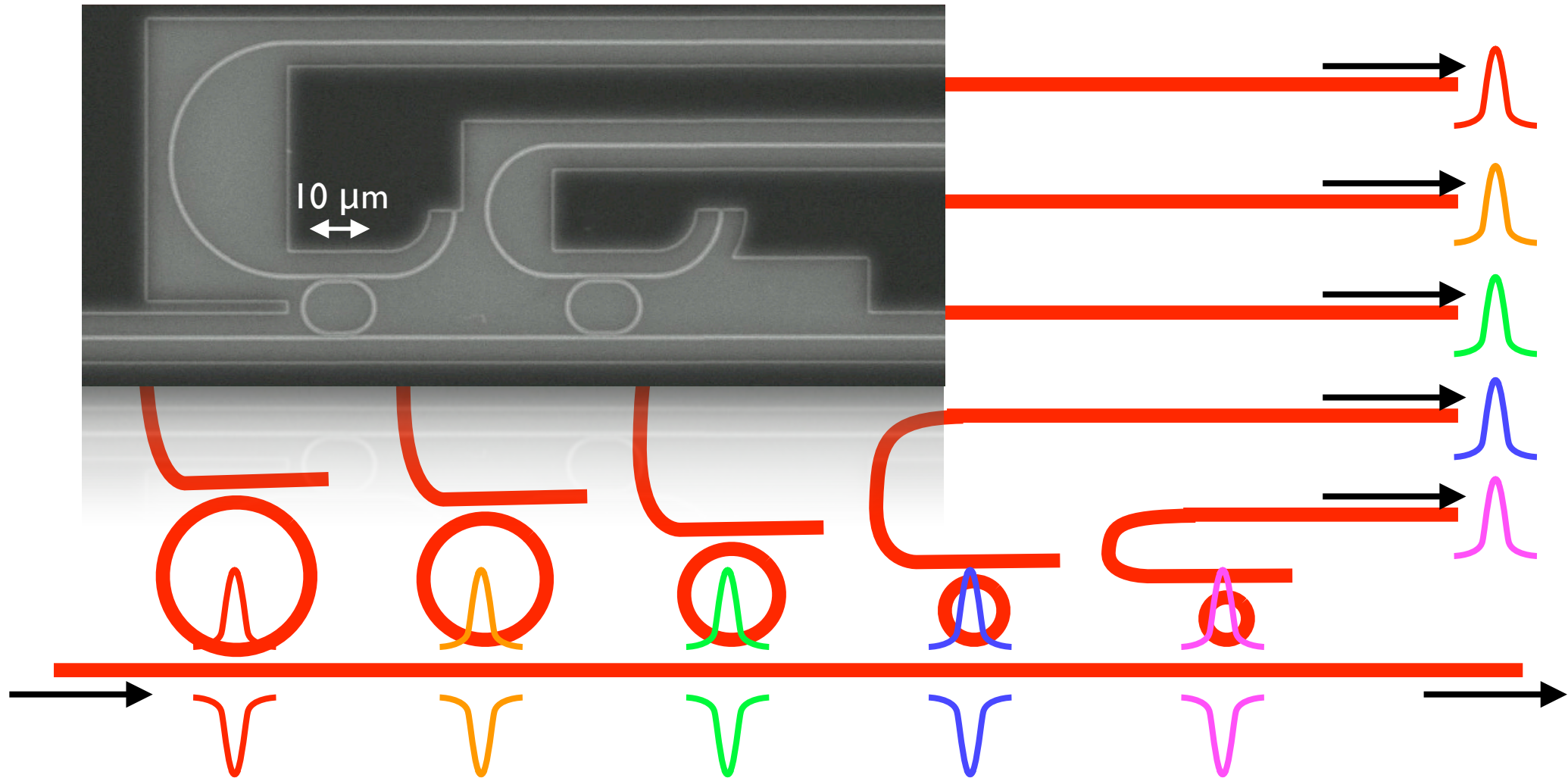

Gevoelig voor nanometers

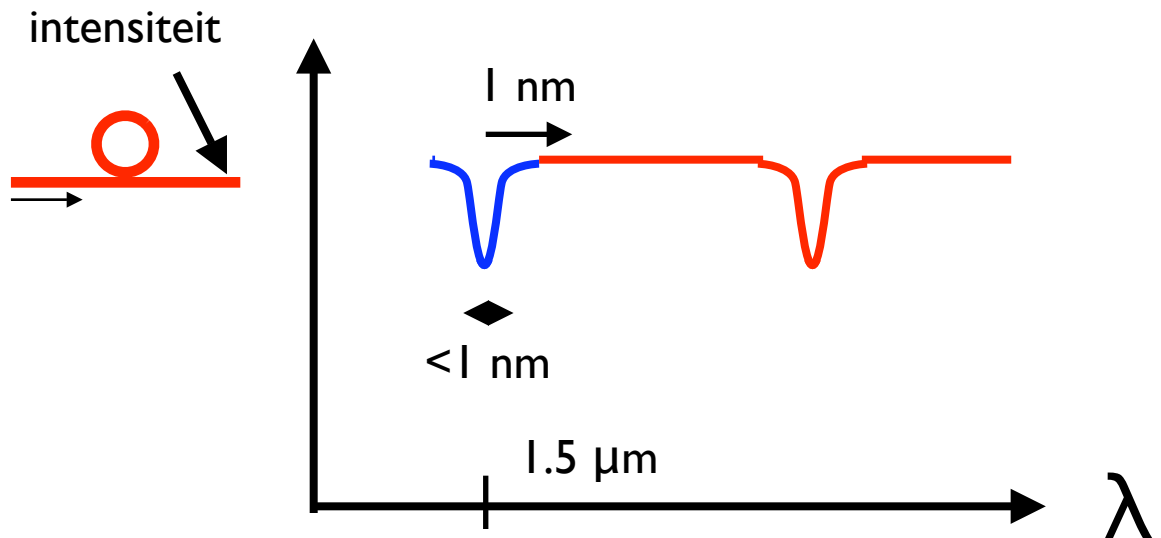
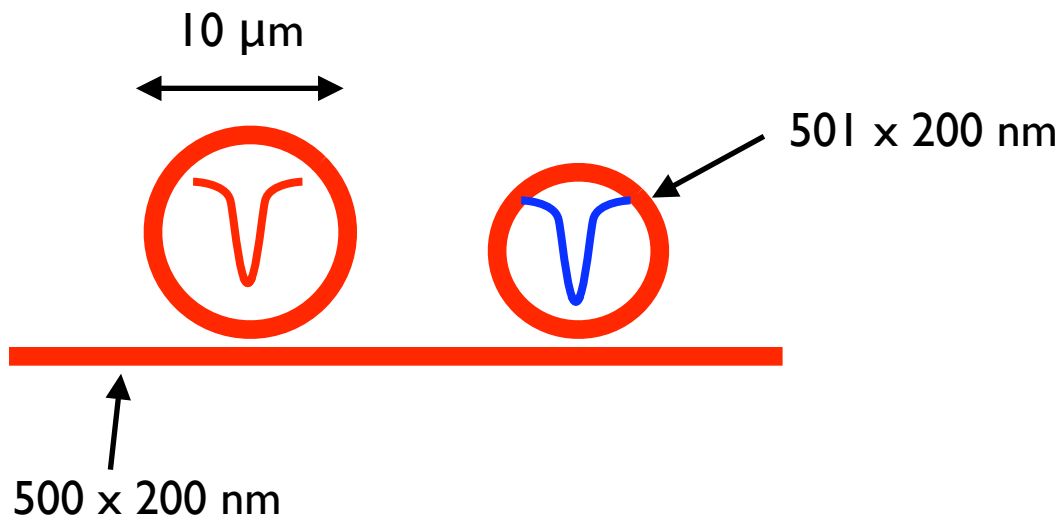

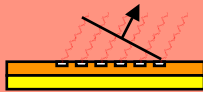
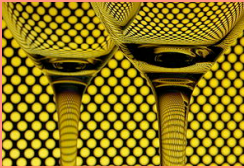

Nanofotonisch!

Nanofotonisch? Ionenbundels

Fabricage: optische lithografie

Belichten

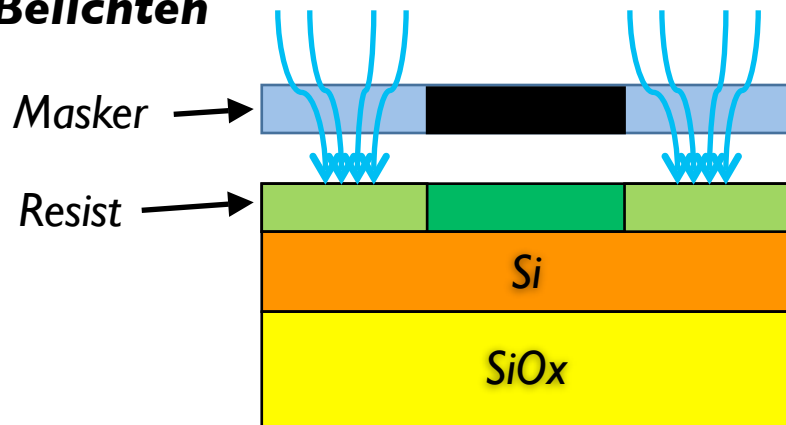

Ontwikkelen

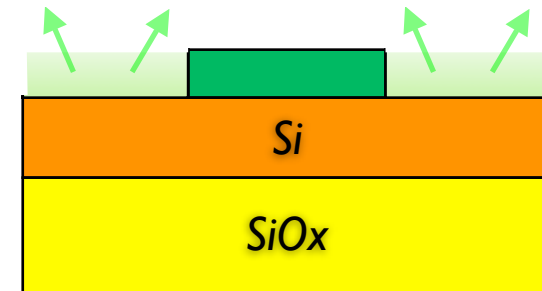

Etsen

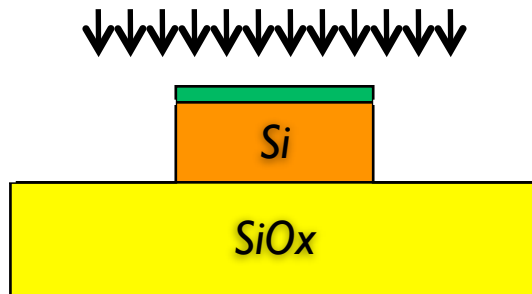

Resist verwijderen

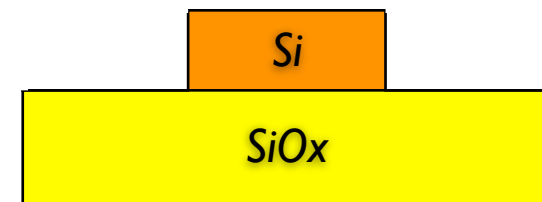

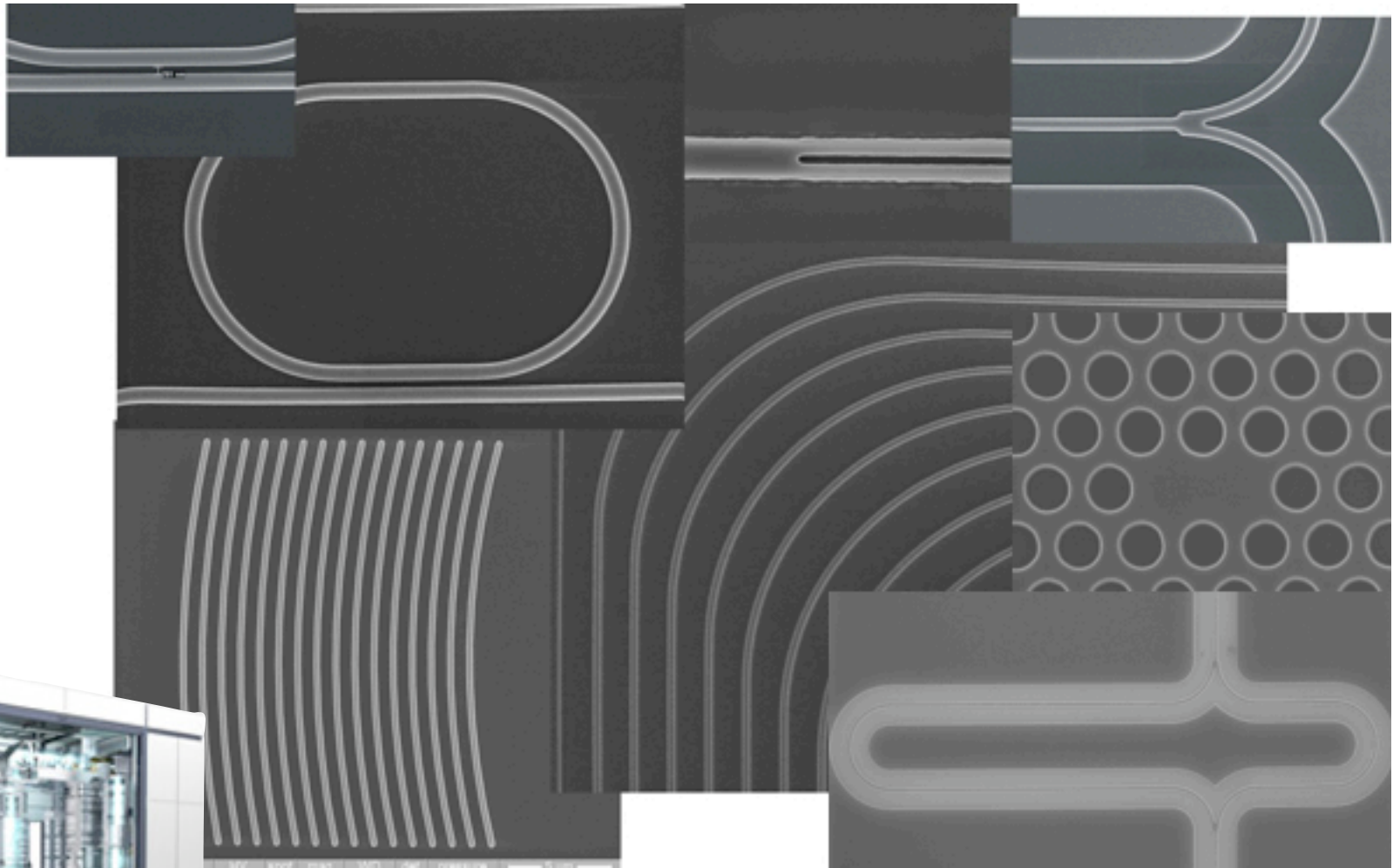

193 nm diep-UV lithografie
(gebruikt voor Pentium4 processoren)

Fabricage: imprint lithografie

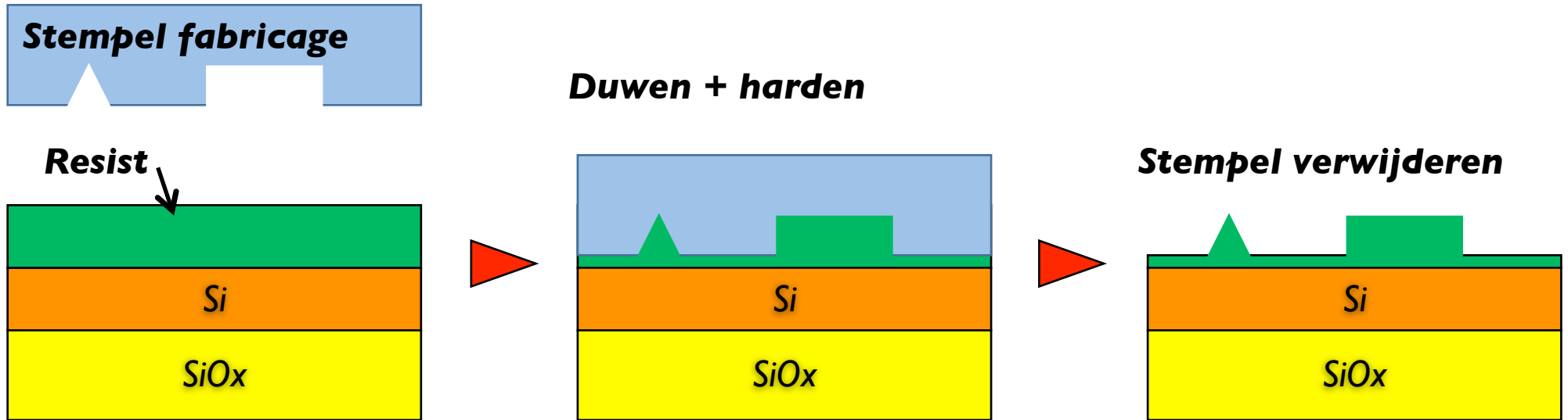

- Optische / imprint lithografie = kopiëren
 - Parallele techniek: vele structuren tegelijk
 - Goedkoop voor grote volumes, duur voor kleine volumes
- Seriële technieken:
 - voor maskers en stempels
 - voor prototypes

▶ Gefocusseerde ionenbundels

Gefocusseerde ionenbundels

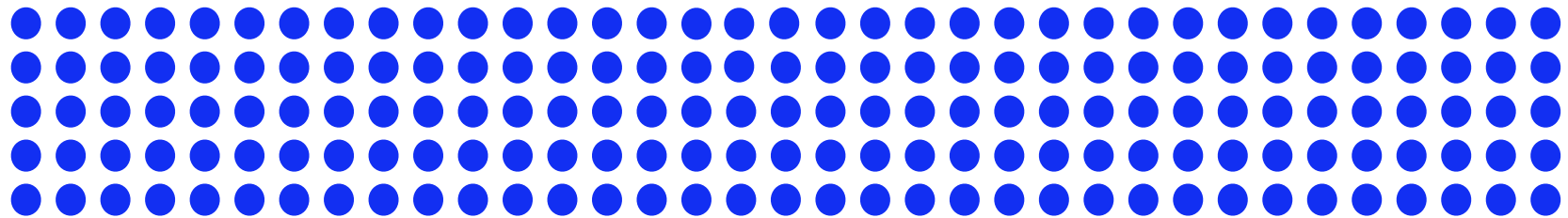

Gefocusseerde ionenbundels

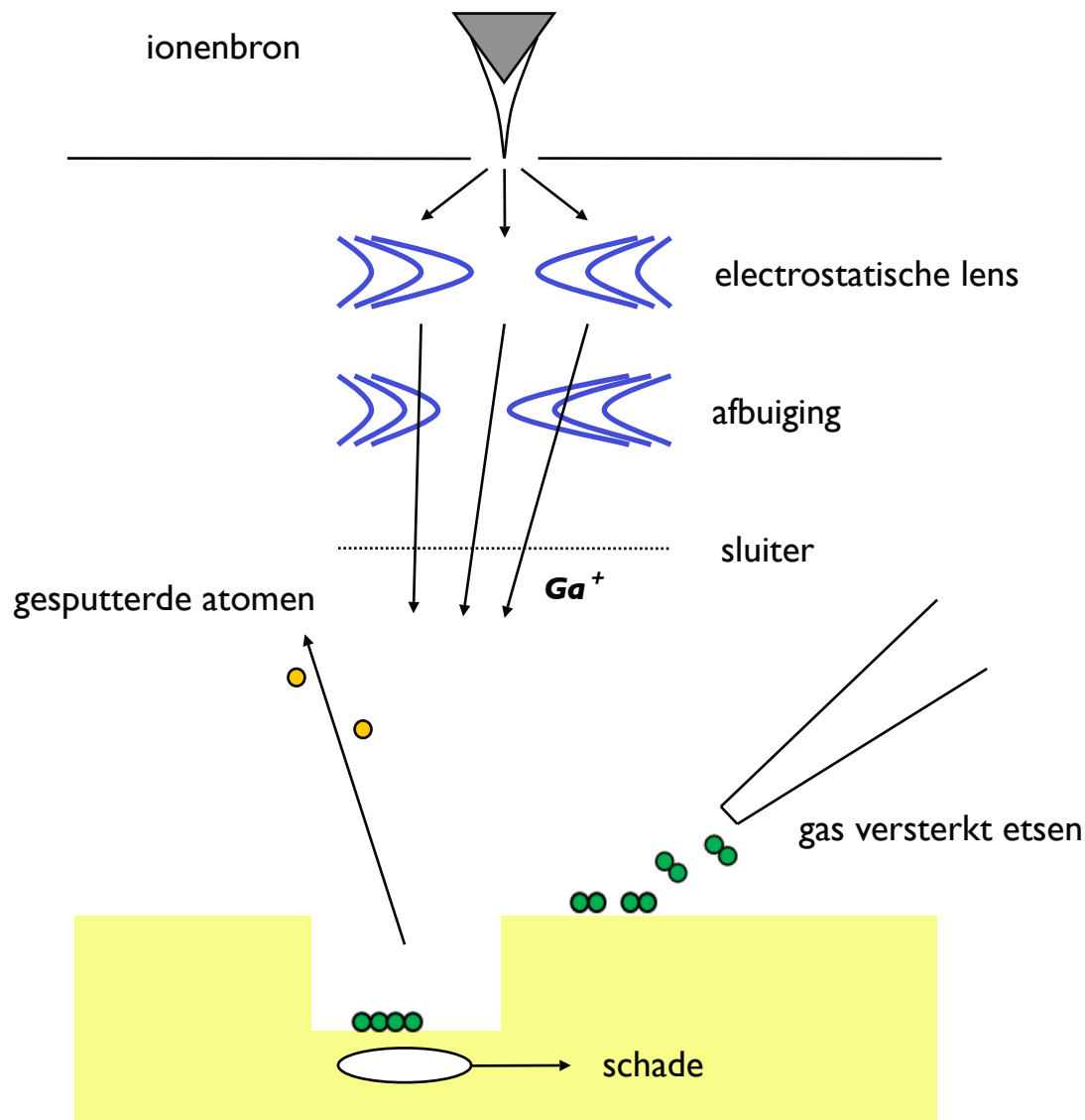

= Focused ion beam

= FIB

1. flexibel = ideaal voor prototypes
2. zeer hoge precisie (nanometers)
3. 3D structuren mogelijk



Gefocusseerde ionenbundels

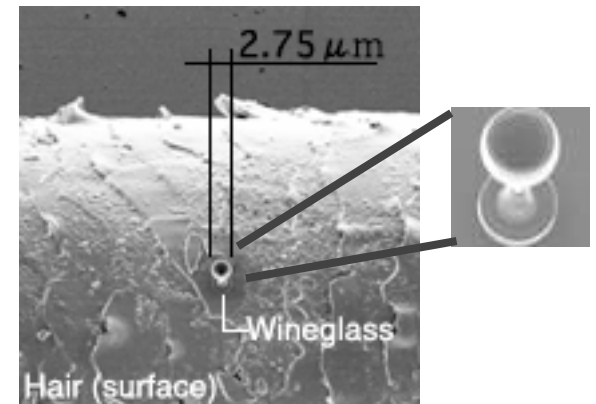

Dit doctoraat:

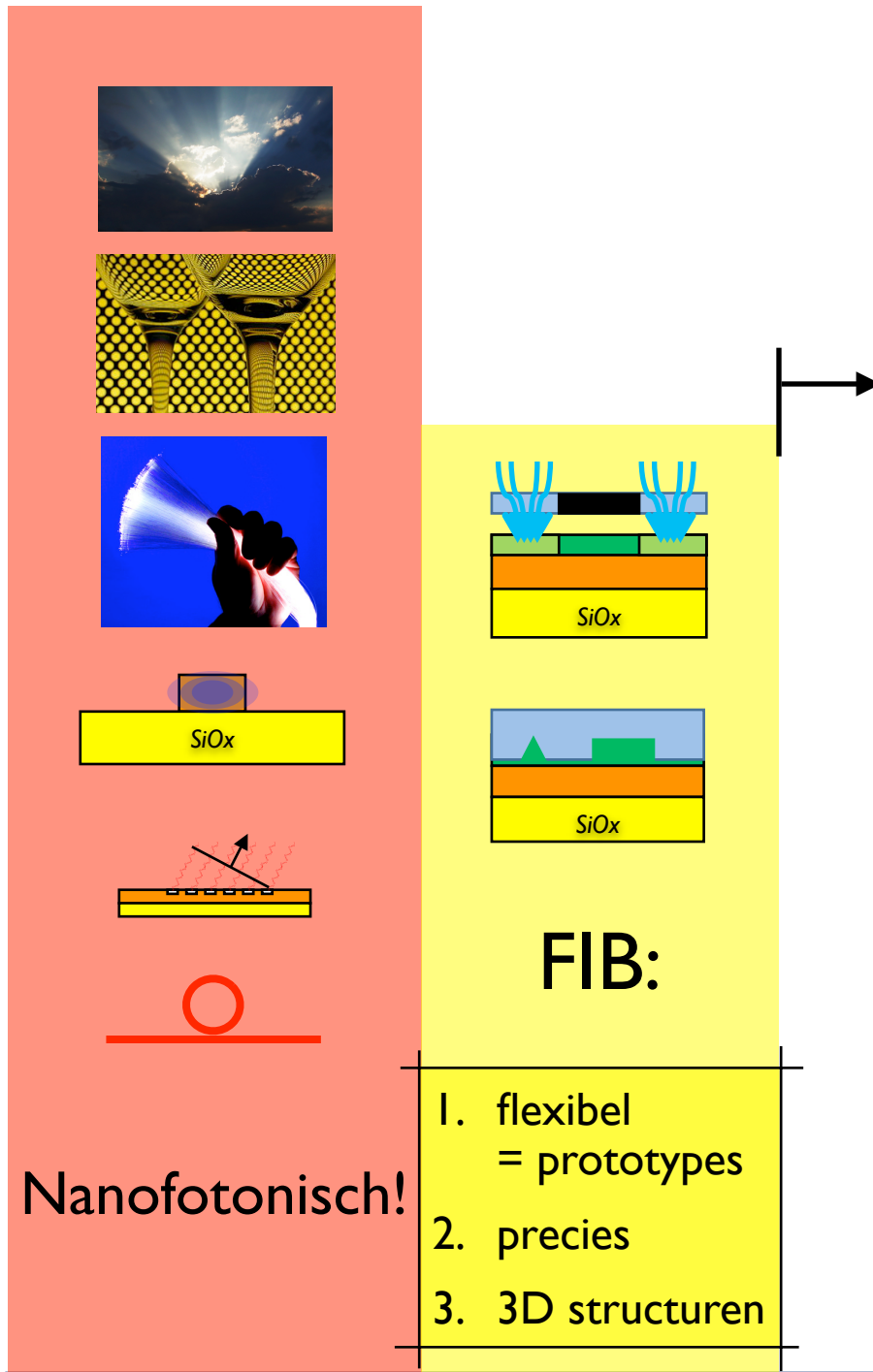

Ionenbundels

Verliezen

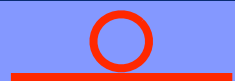
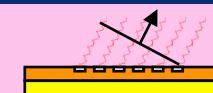

Optische verliezen

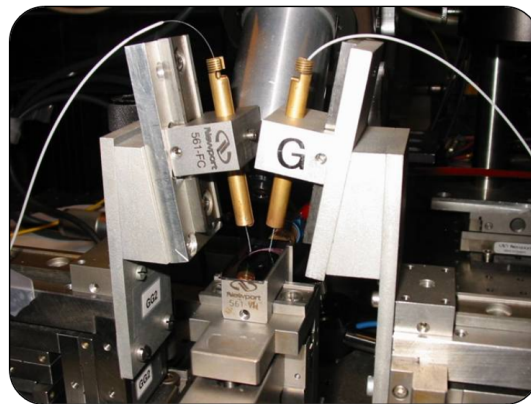
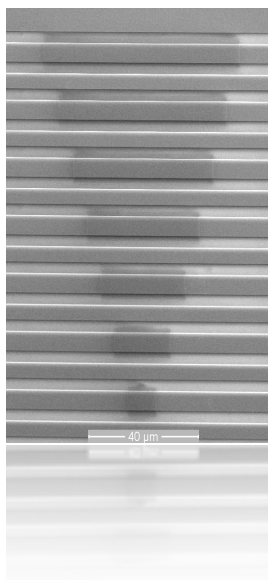

100 % = 0 dB
10 % = -10 dB
1 % = -20 dB

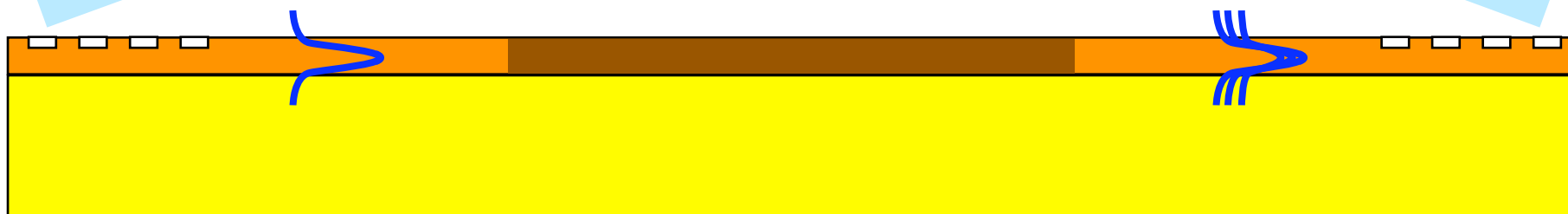

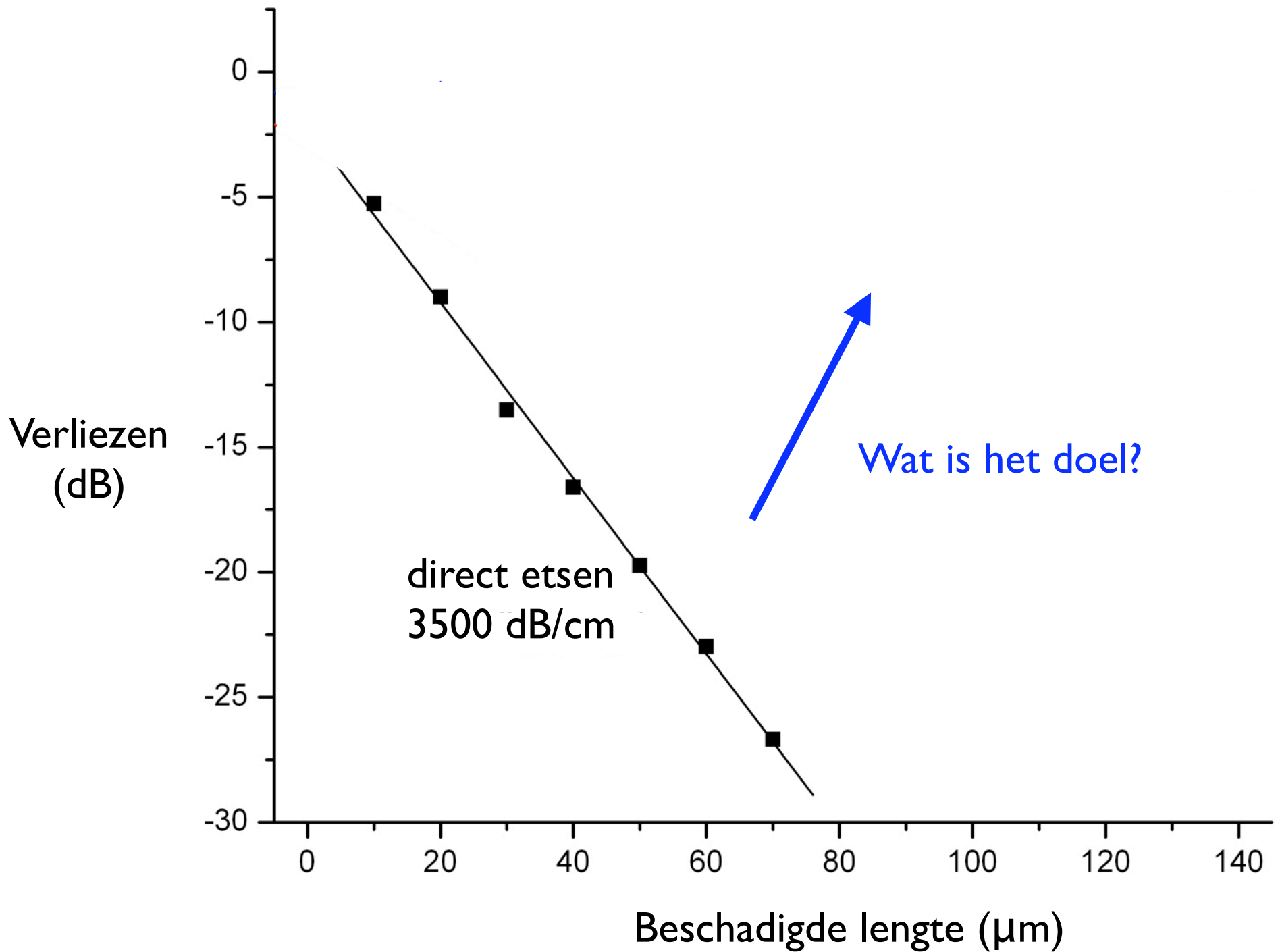

Gas versterkt etsen

- Jodium gas (dijood)
- Versneld etsproces
- Minder ionen = minder schade

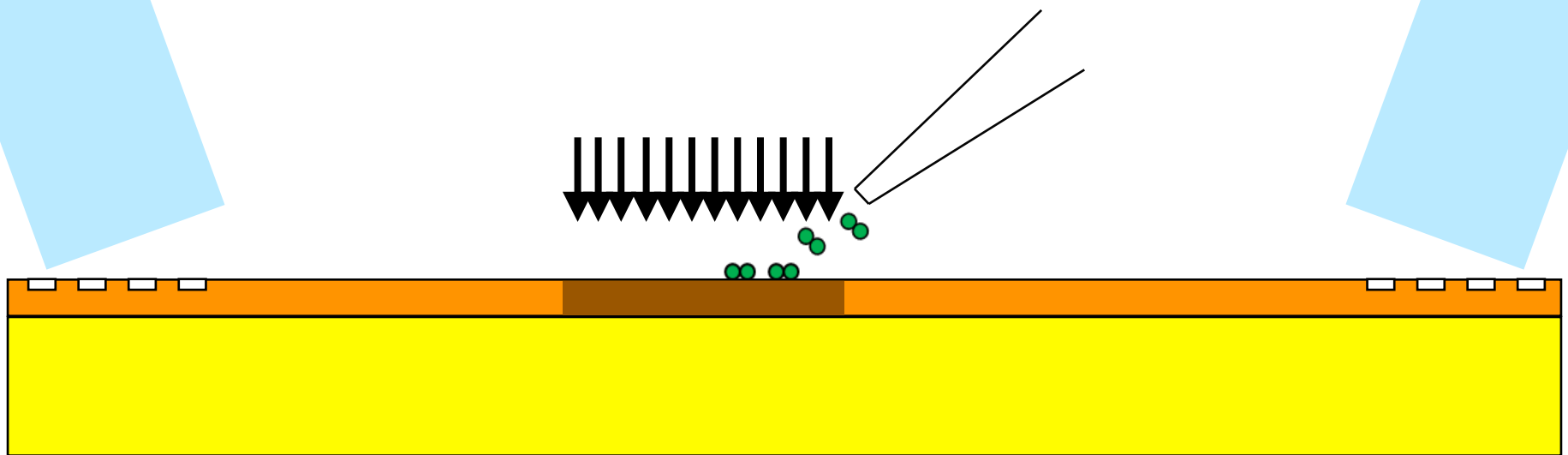

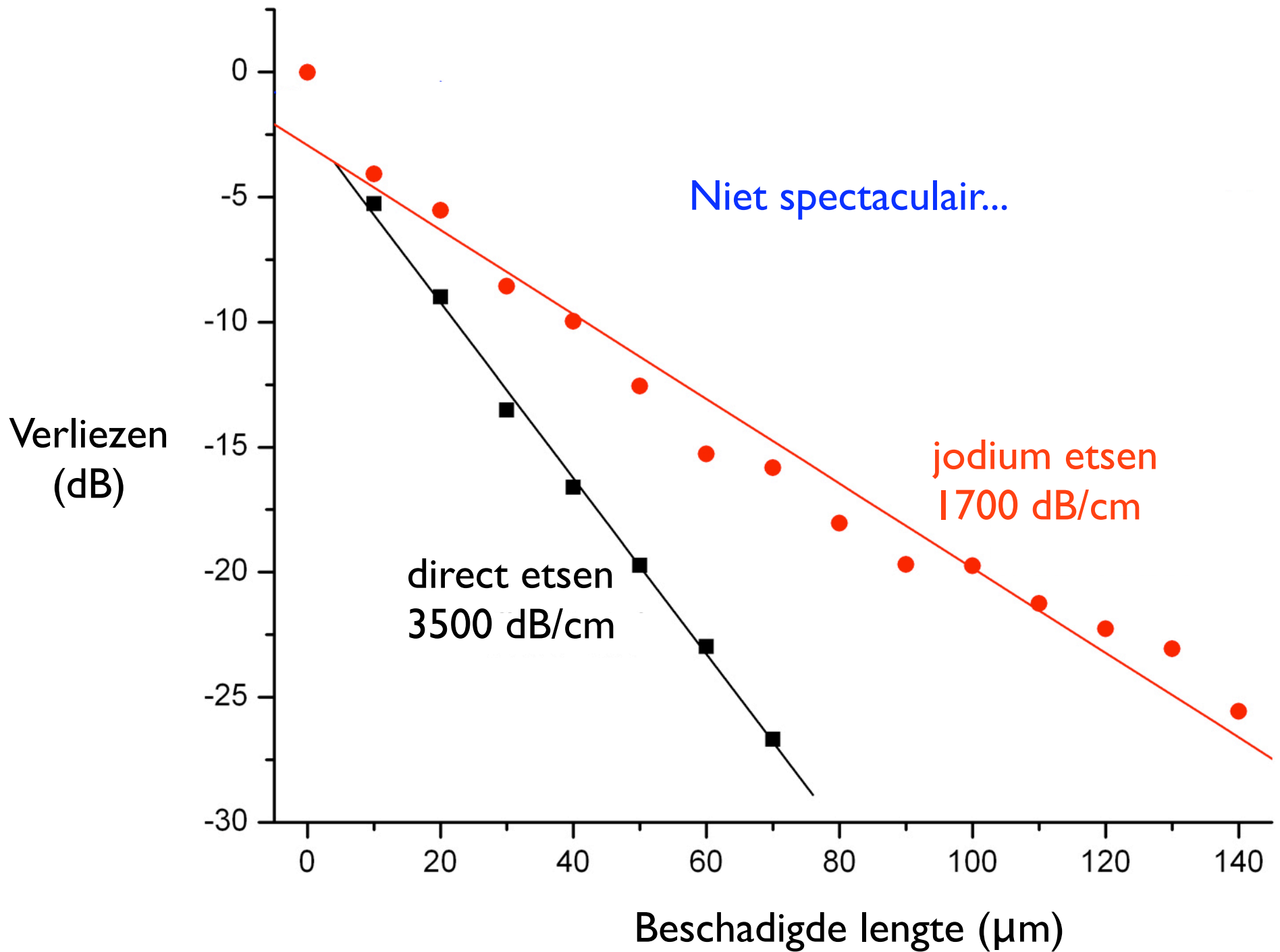

Wat is er aan de hand?

Verschillende
analysetechnieken:
EDX, EBSD, XPS



Verwijderen
door bakken op
300°C

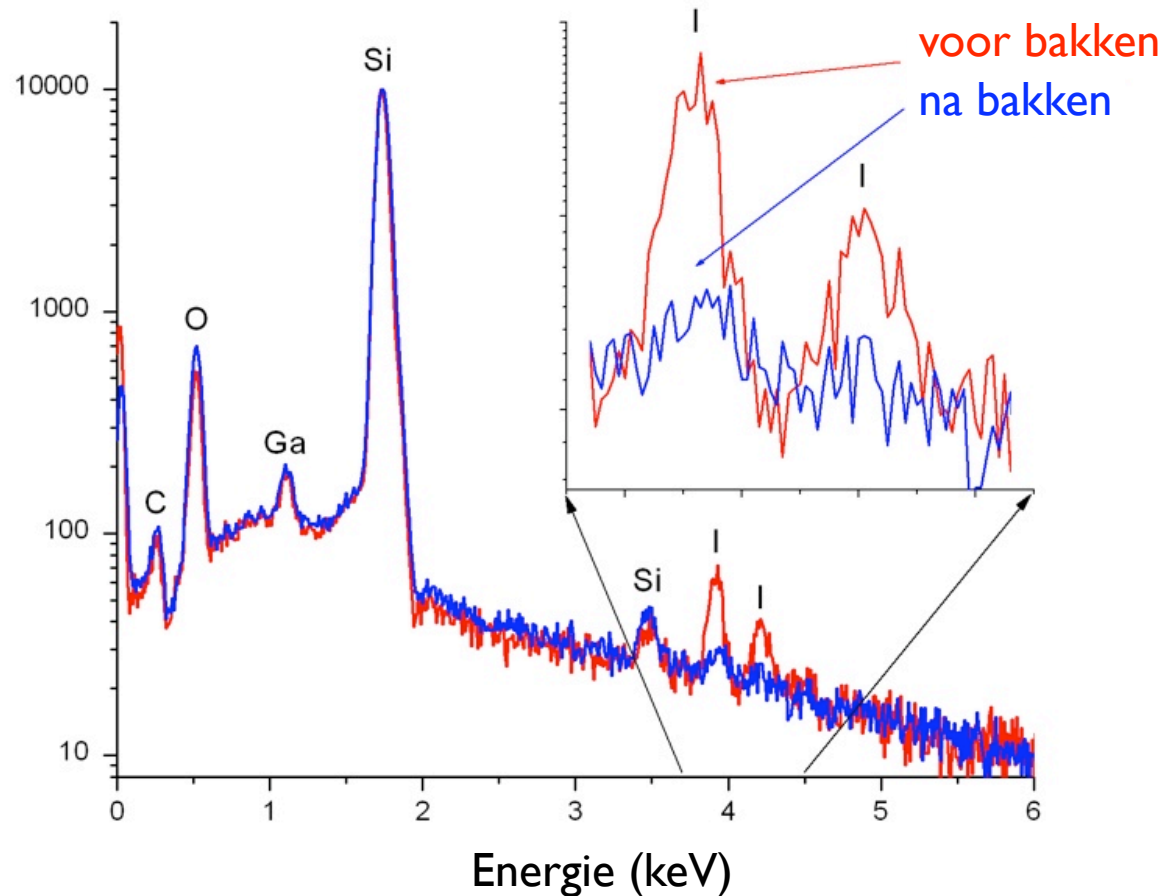

Verliezen

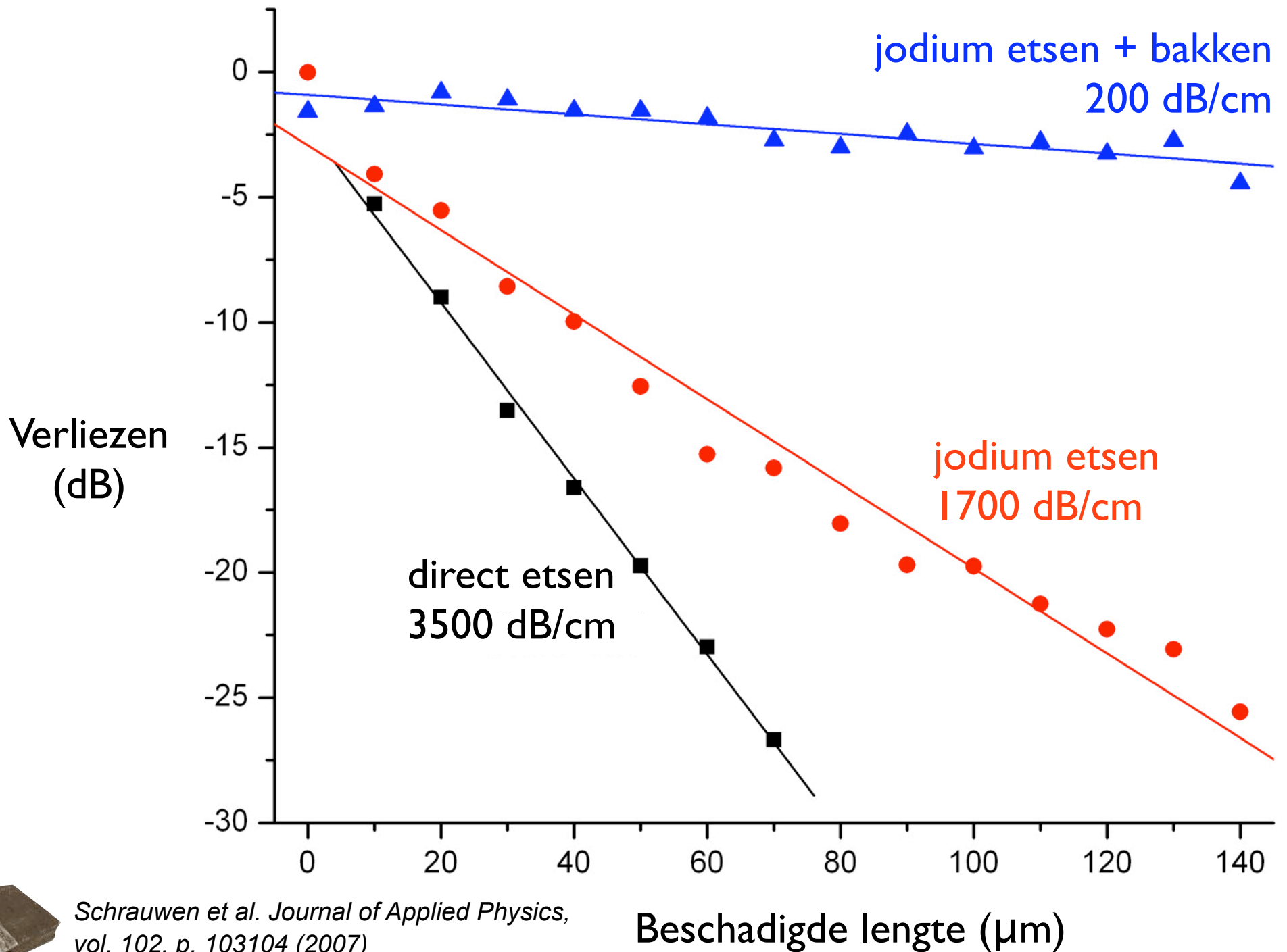

Schrauwen et al. *Journal of Applied Physics*,
vol. 102, p. 103104 (2007)

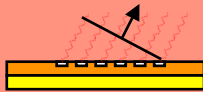
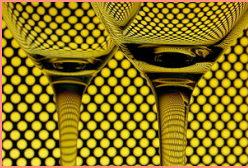

Nanofotonisch!

Dit doctoraat:

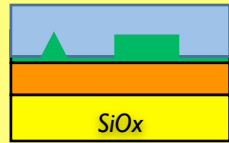
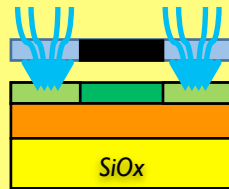

FIB:

- 1. flexibel = prototypes
- 2. precies
- 3. 3D structuren

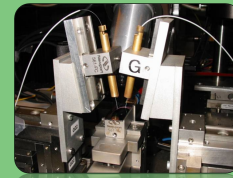

Jodium blijft plakken

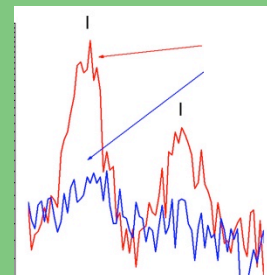

Verliezen

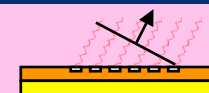

Gewone roosterkoppelaar

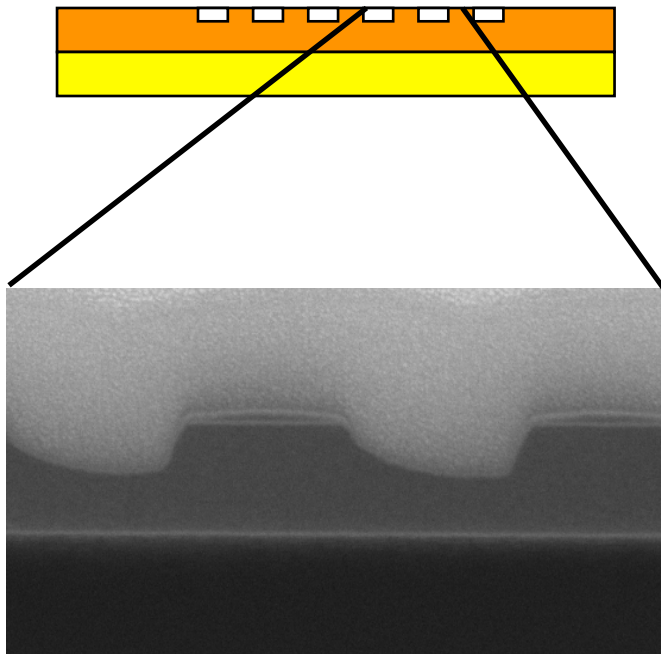

Even goed als
bestaande technieken!

Koppelefficientie (dB)

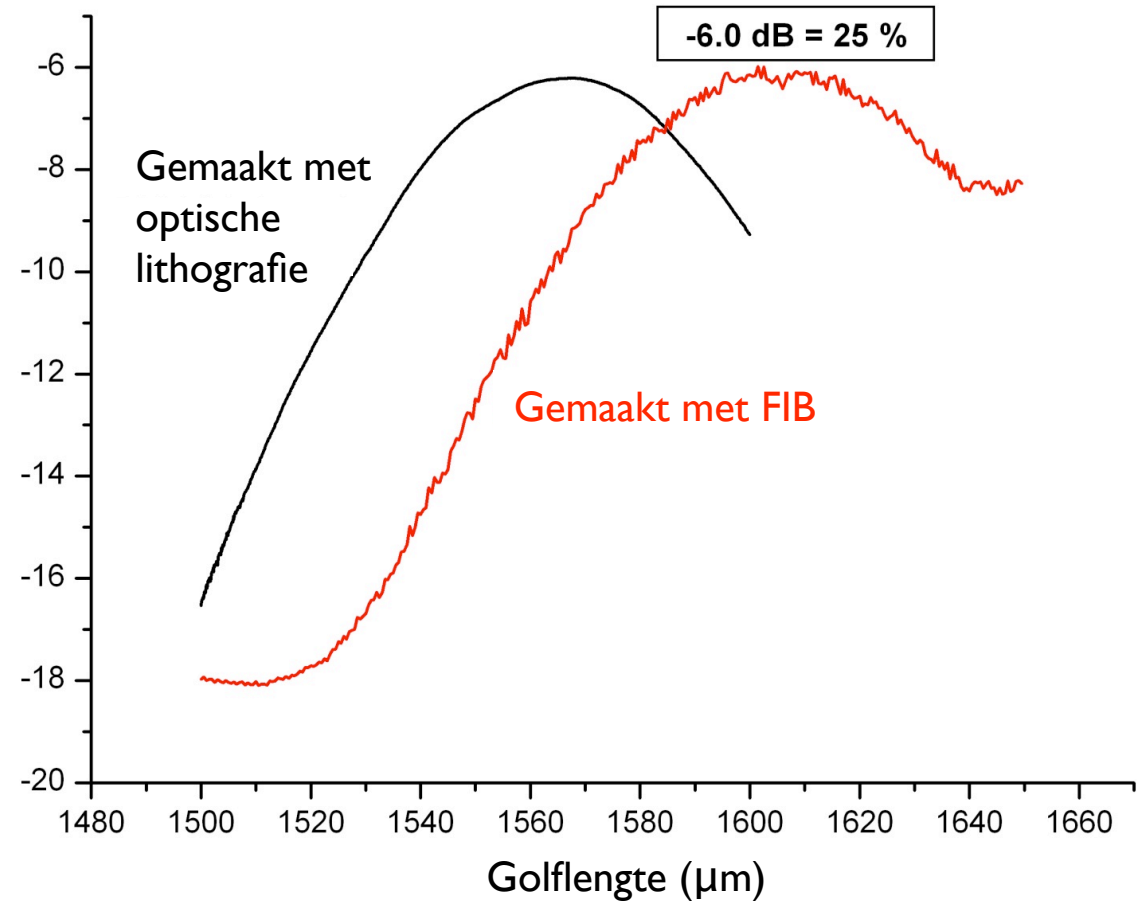

Schrauwen et al. *Applied Physics Letters*,
vol. 89, p.141102 (2006)

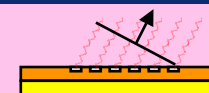

Schuine roosterkoppelaar

Koppelverlies (dB)

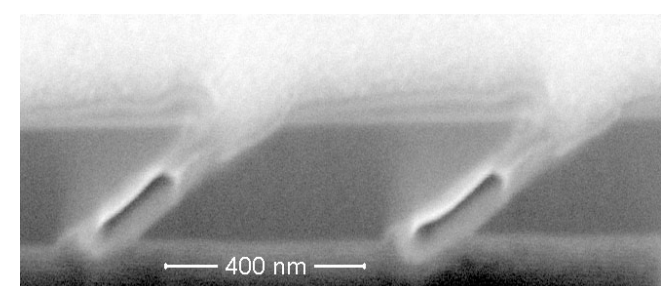
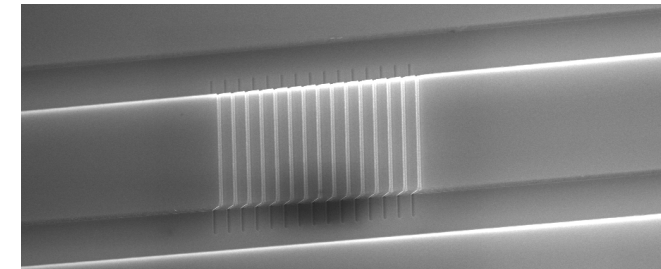
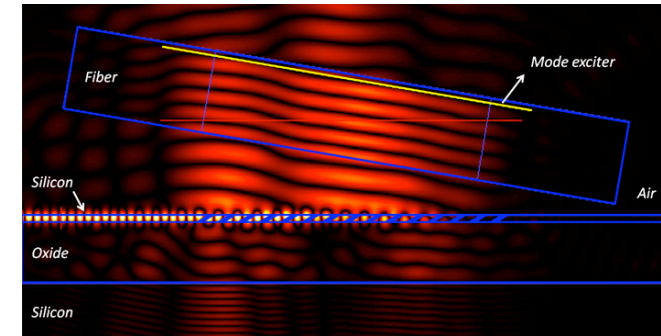
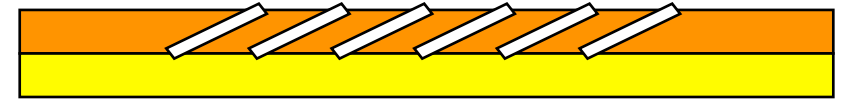
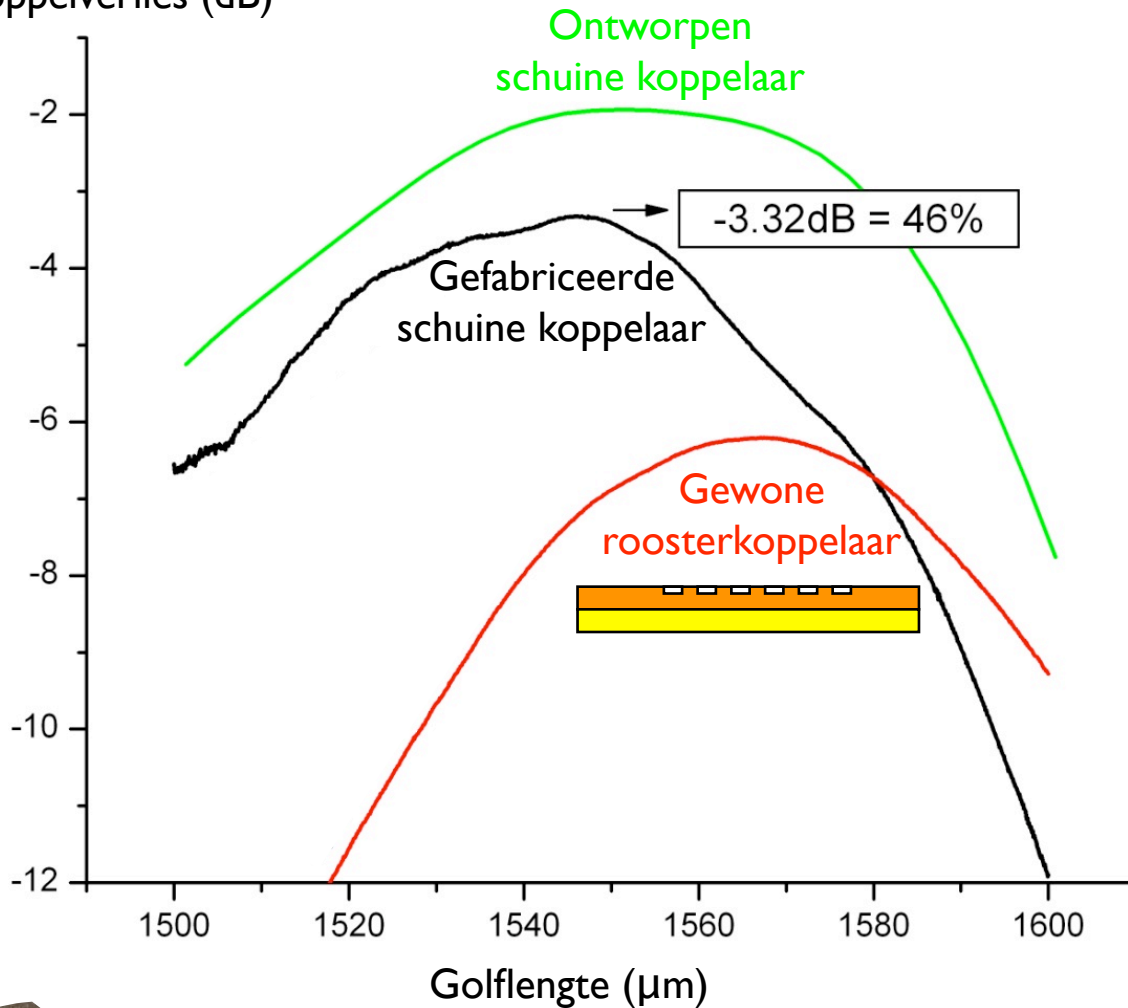

Schrauwen et al. *IEEE Photonics Technology Letters*, vol. 19(11), p.816-818 (2007)

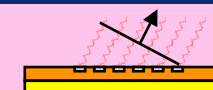

Verticale koppeling?

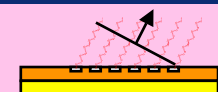
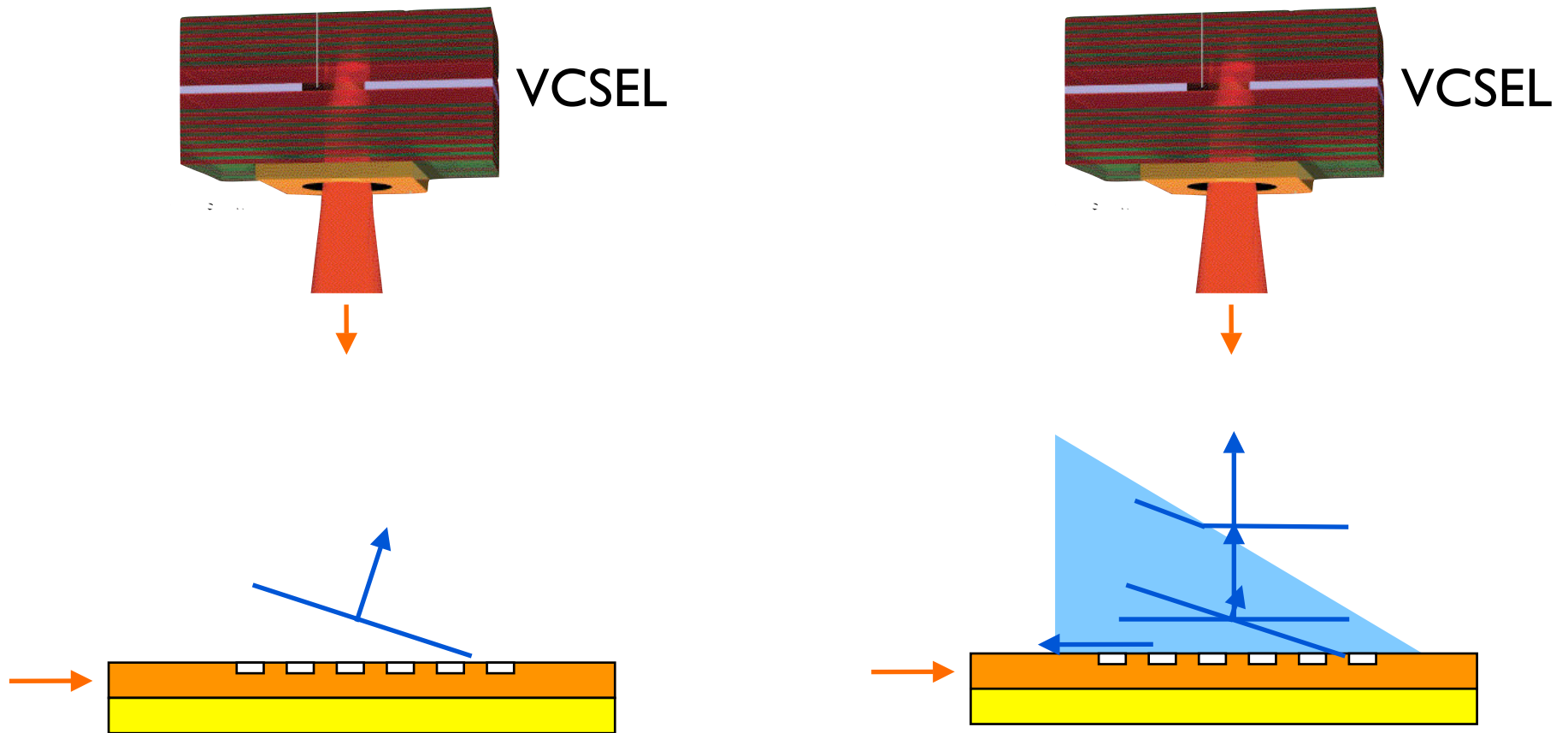

FIB schrijven stempel + imprint

Stempel fabricage

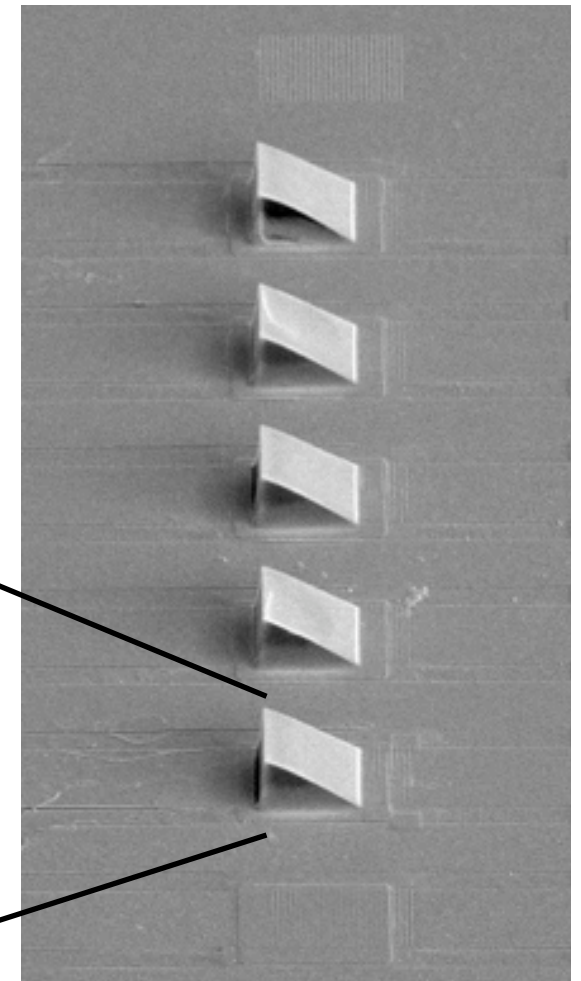
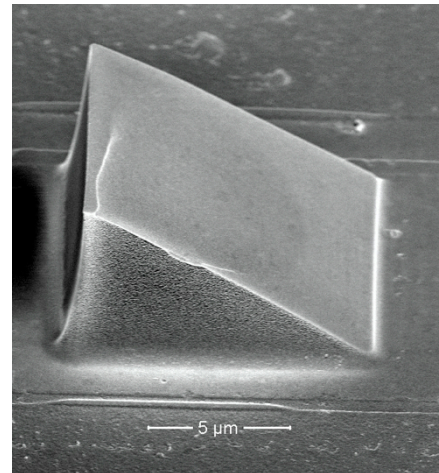
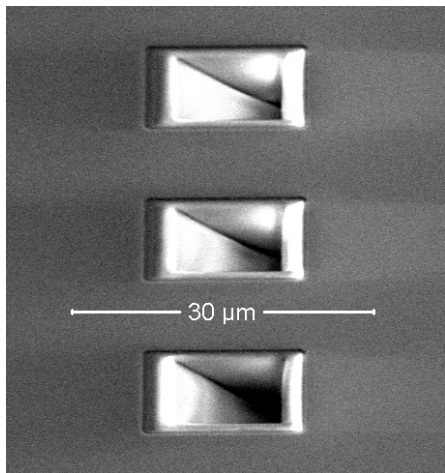
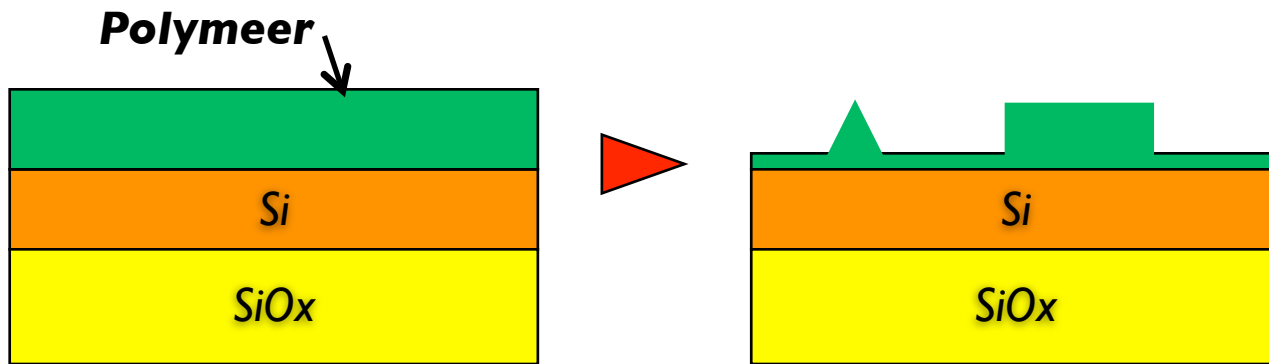

Schrauwen et al. US Patent Pending (2008)

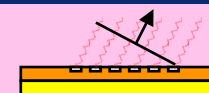

Dit doctoraat:

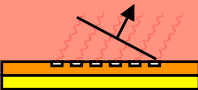
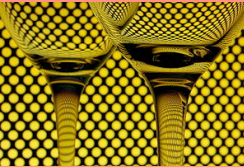

Nanofotonisch!

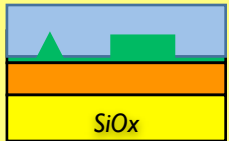
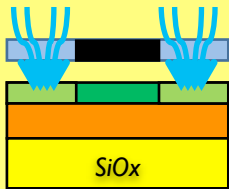

FIB:

- 1. flexibel = prototypes
- 2. precies
- 3. 3D structuren

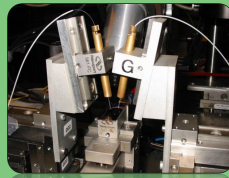

Jodium blijft plakken

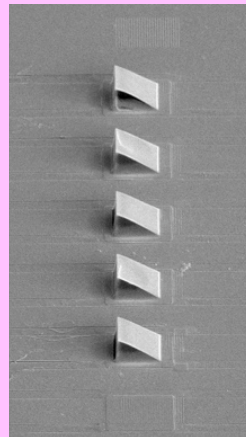
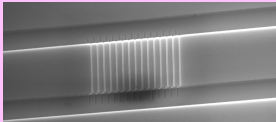
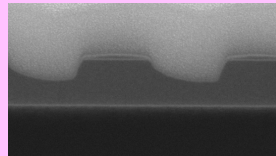
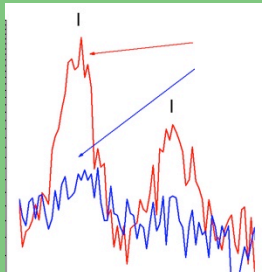

Verliezen

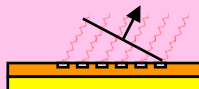

Ringresonatoren zijn sensoren

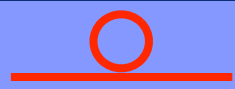
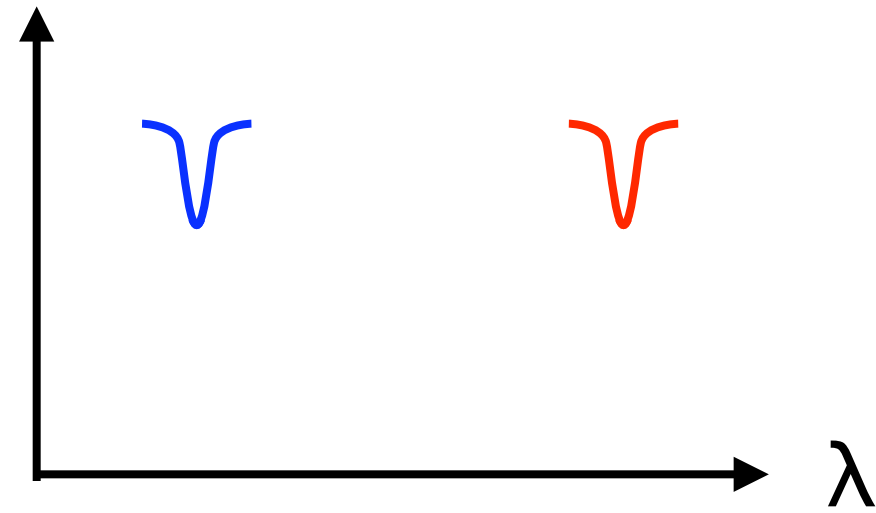
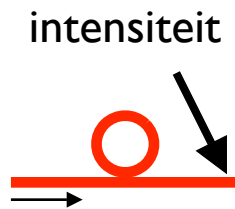
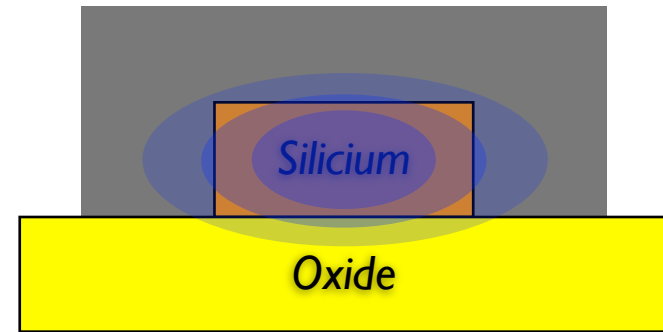
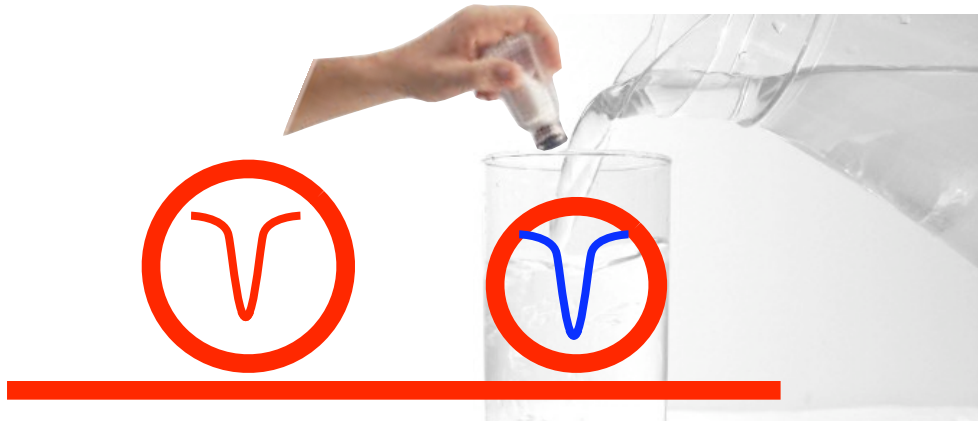

Ringresonatoren zijn sensoren

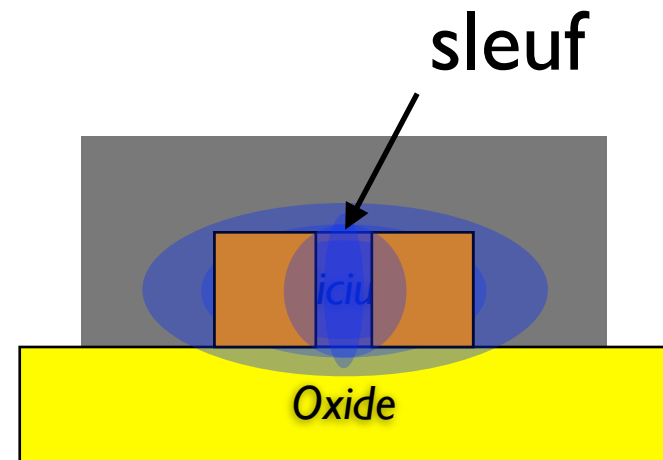
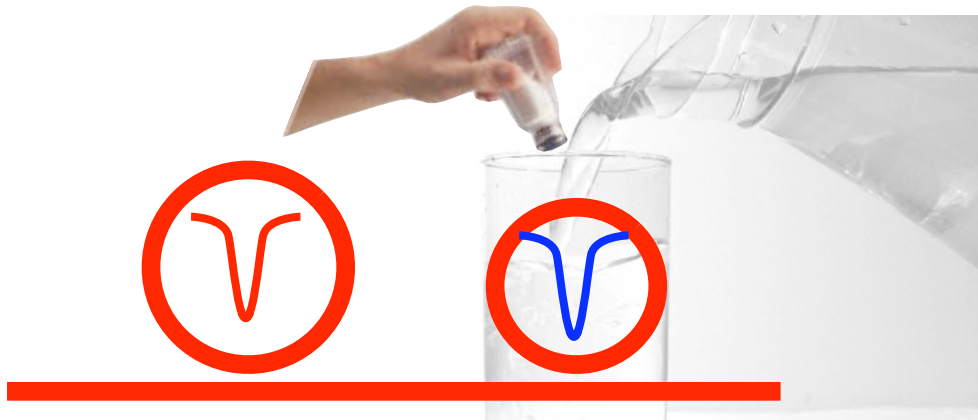

Ringen met
sleuf zijn
gevoeliger

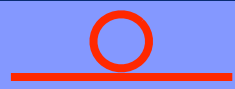
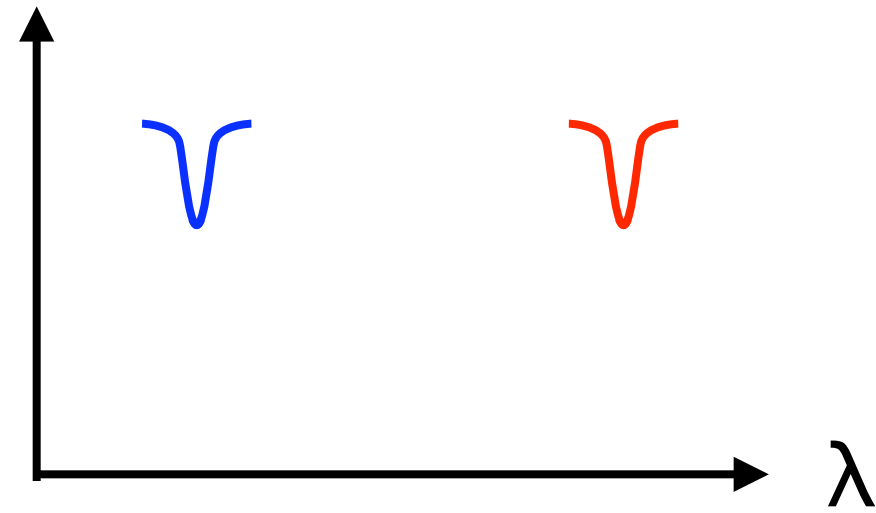
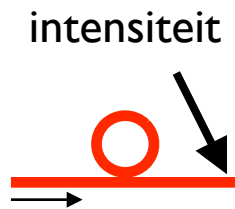

Sleuven gemaakt met FIB

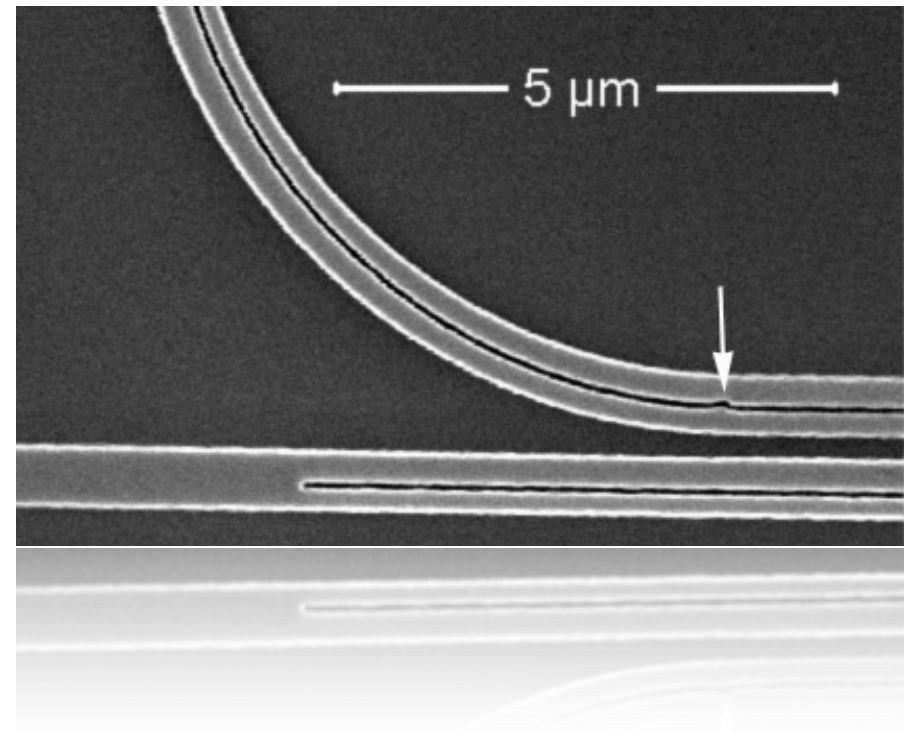
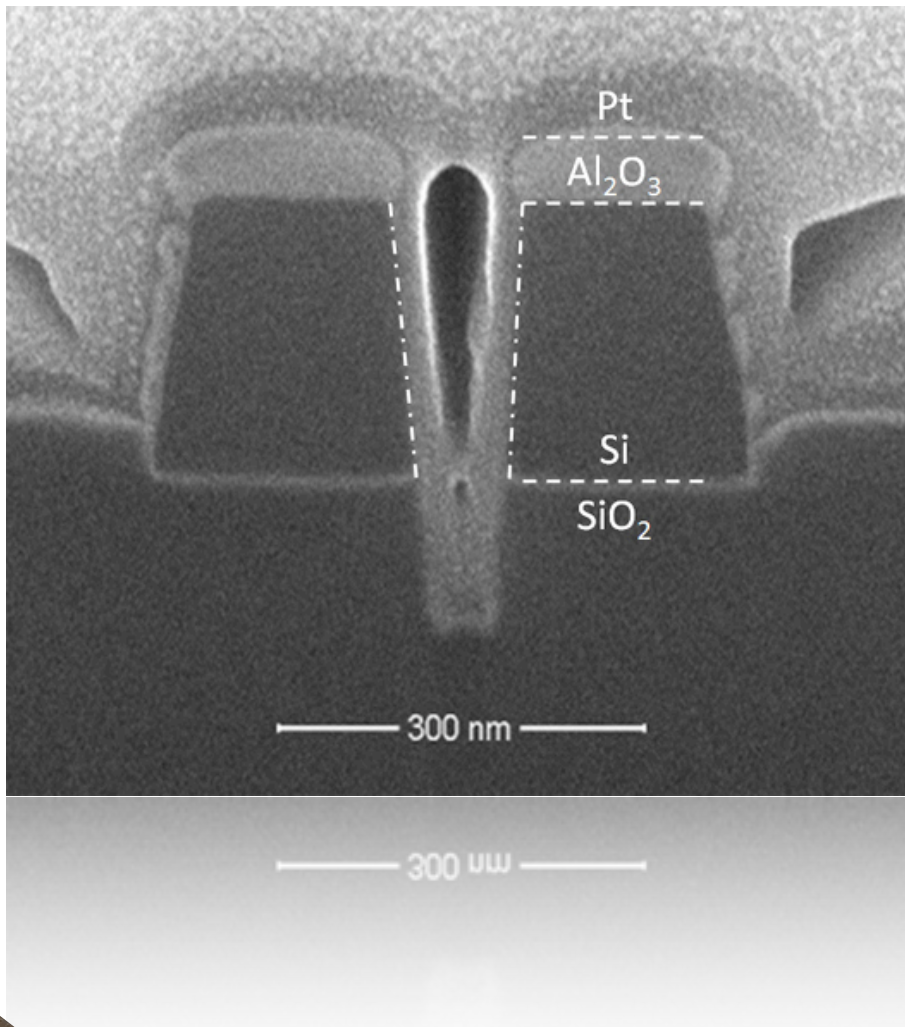

Schrauwen et al. *IEEE Photonics Technology Letters*,
vol. 20(23), p.2004 (2008)

Heel gevoelig

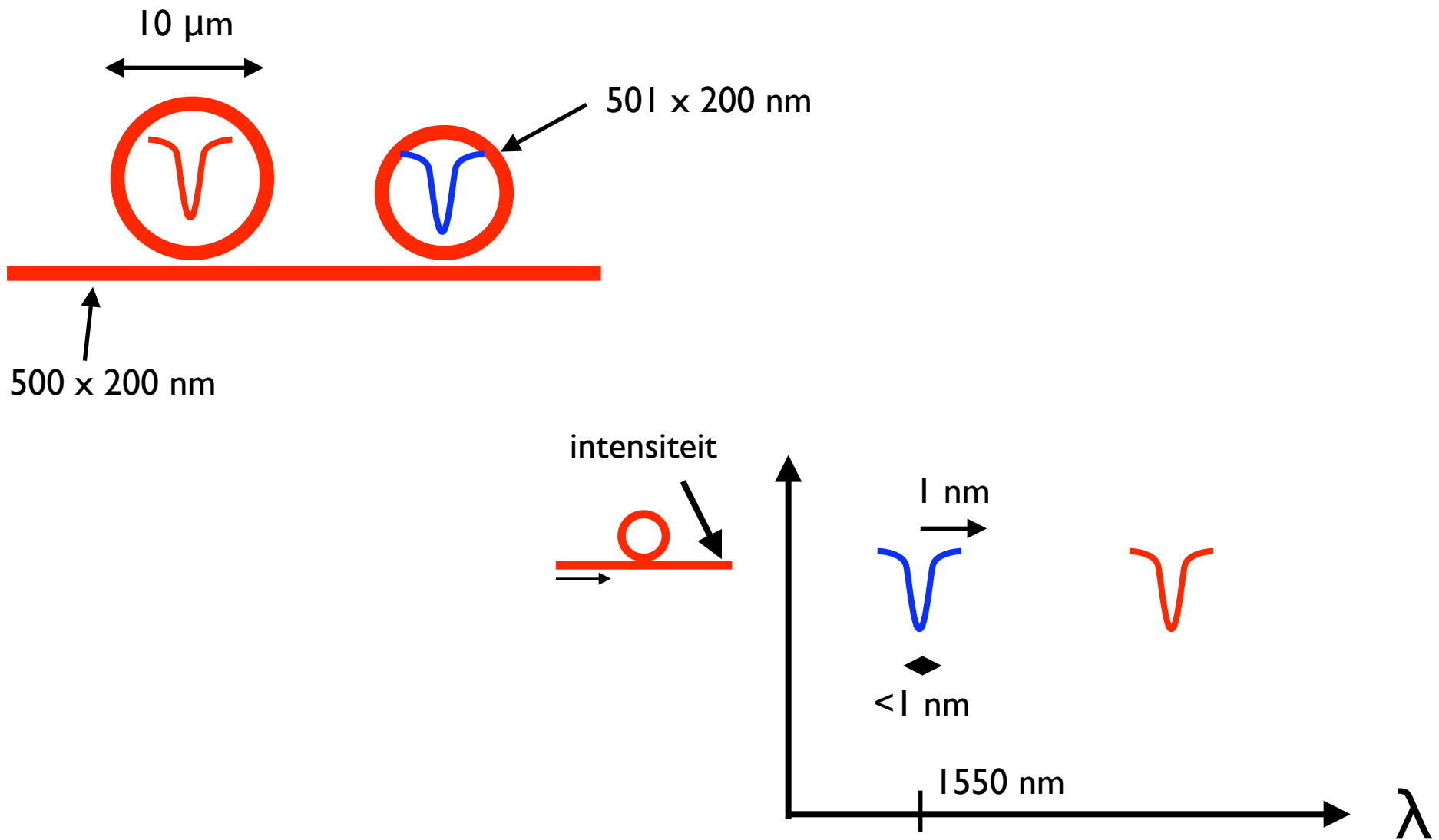

En daarom moeilijk om te maken

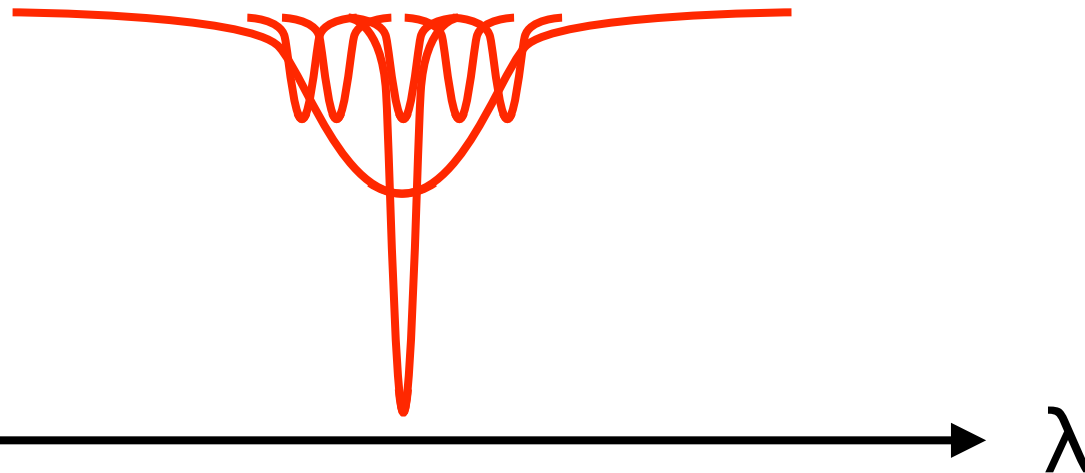
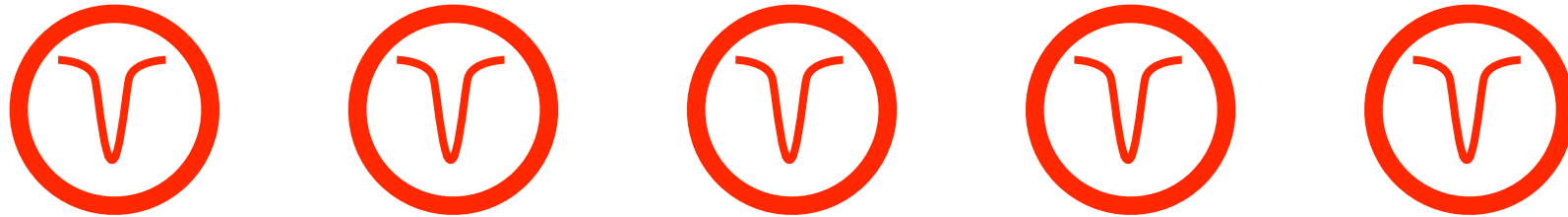

Trimmen met seriële techniek

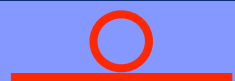
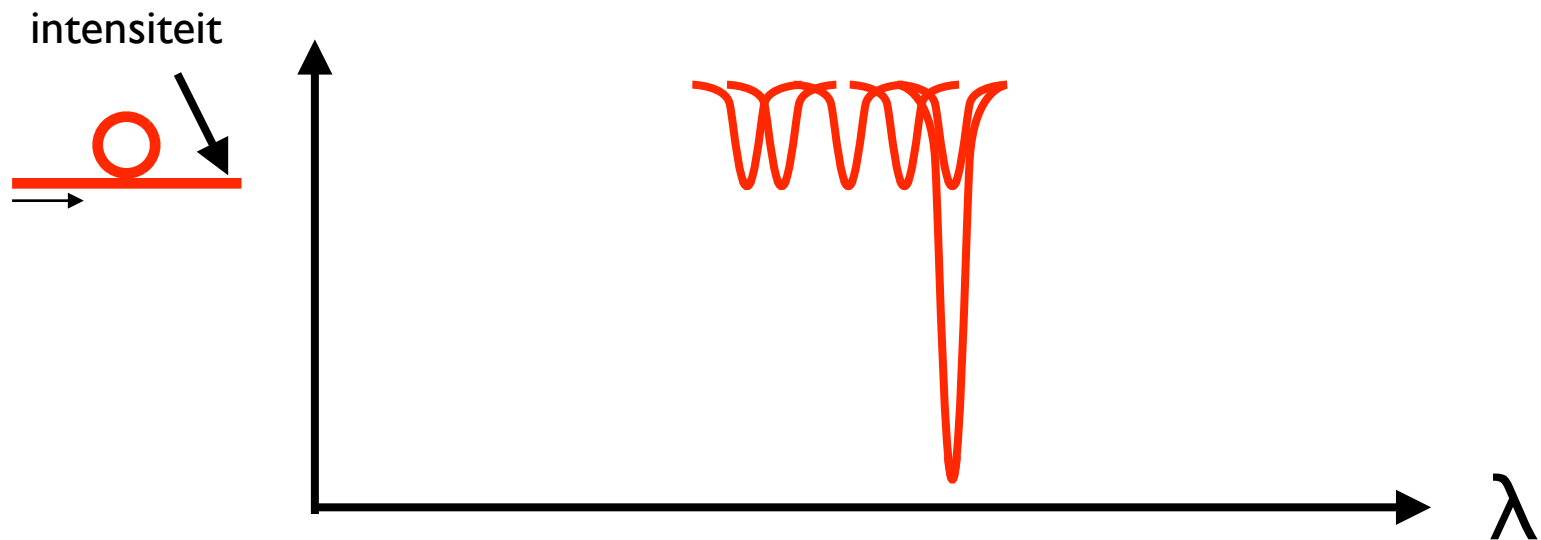
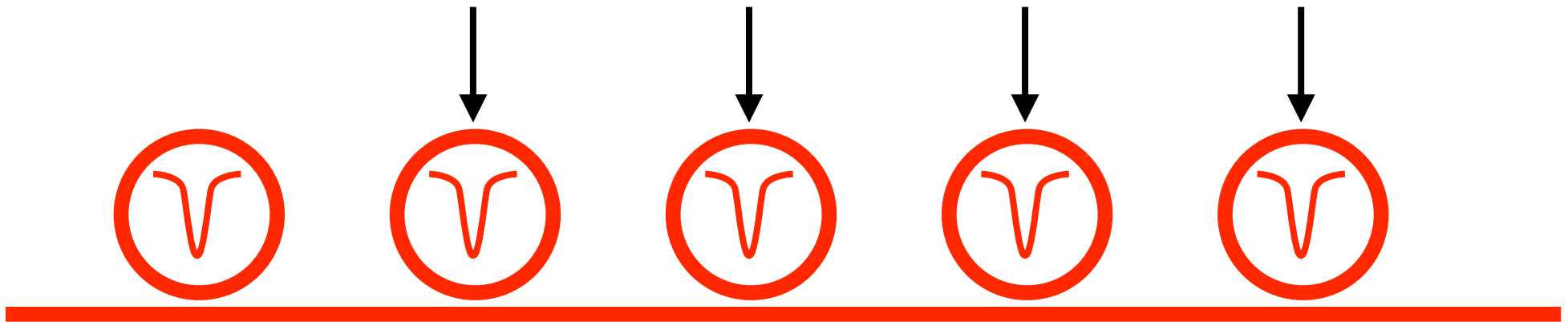

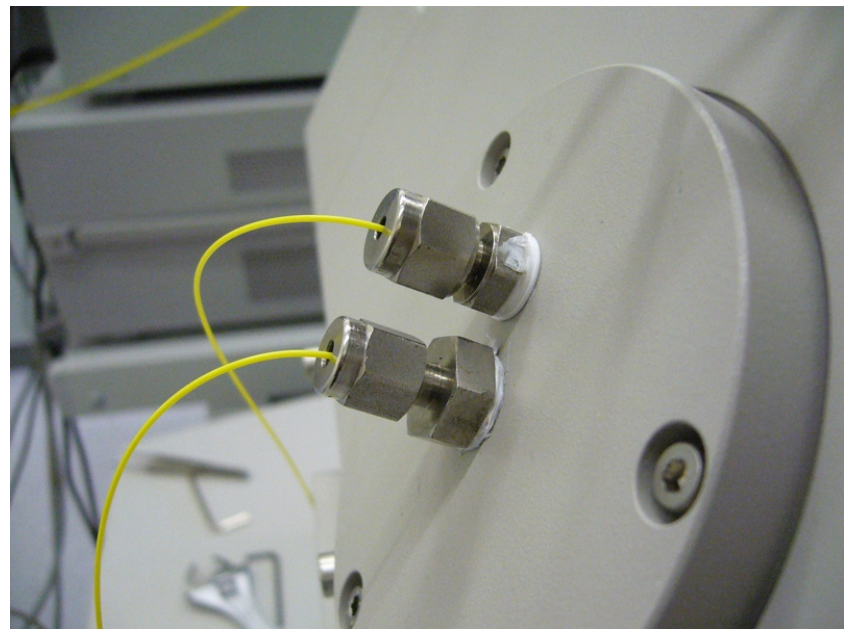
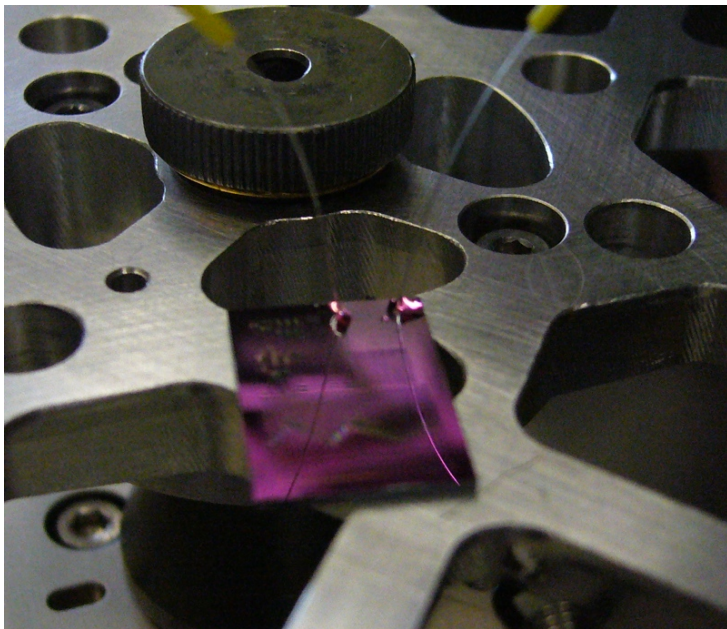
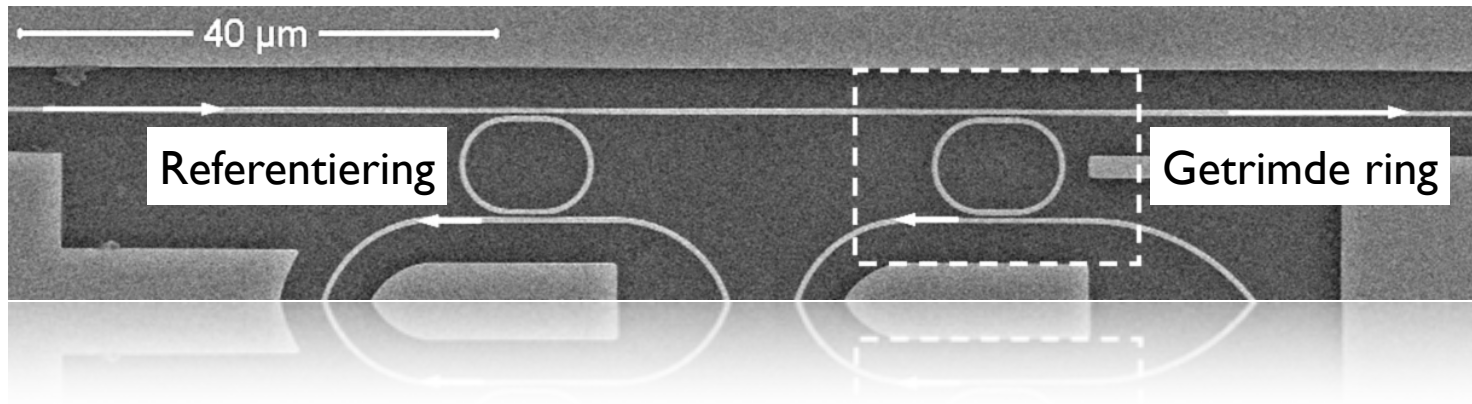

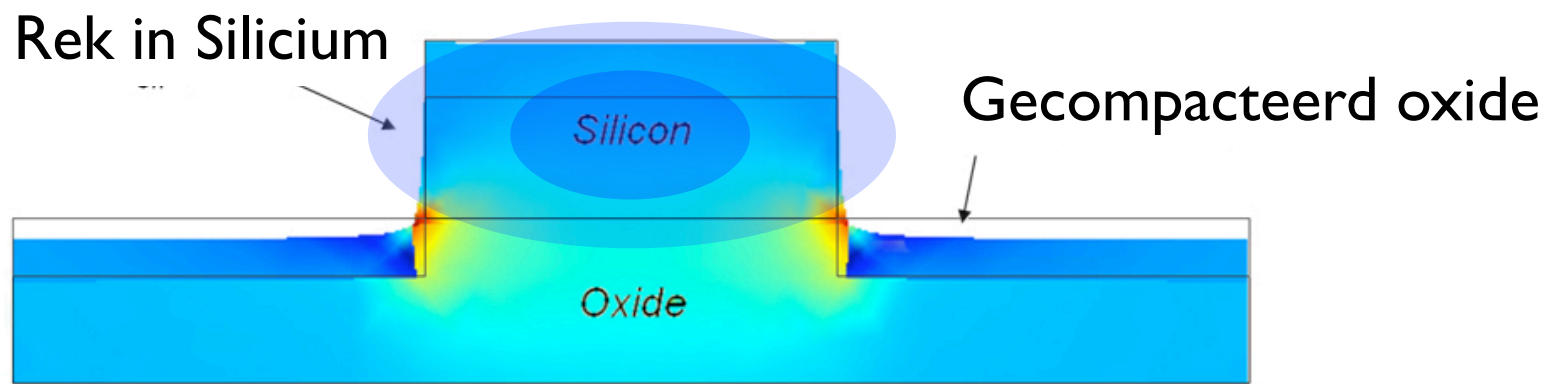
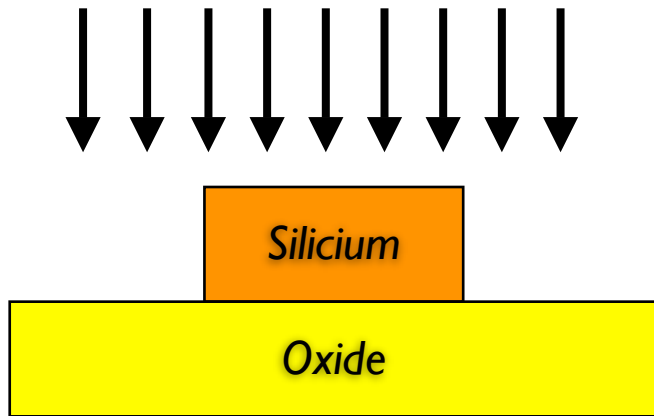

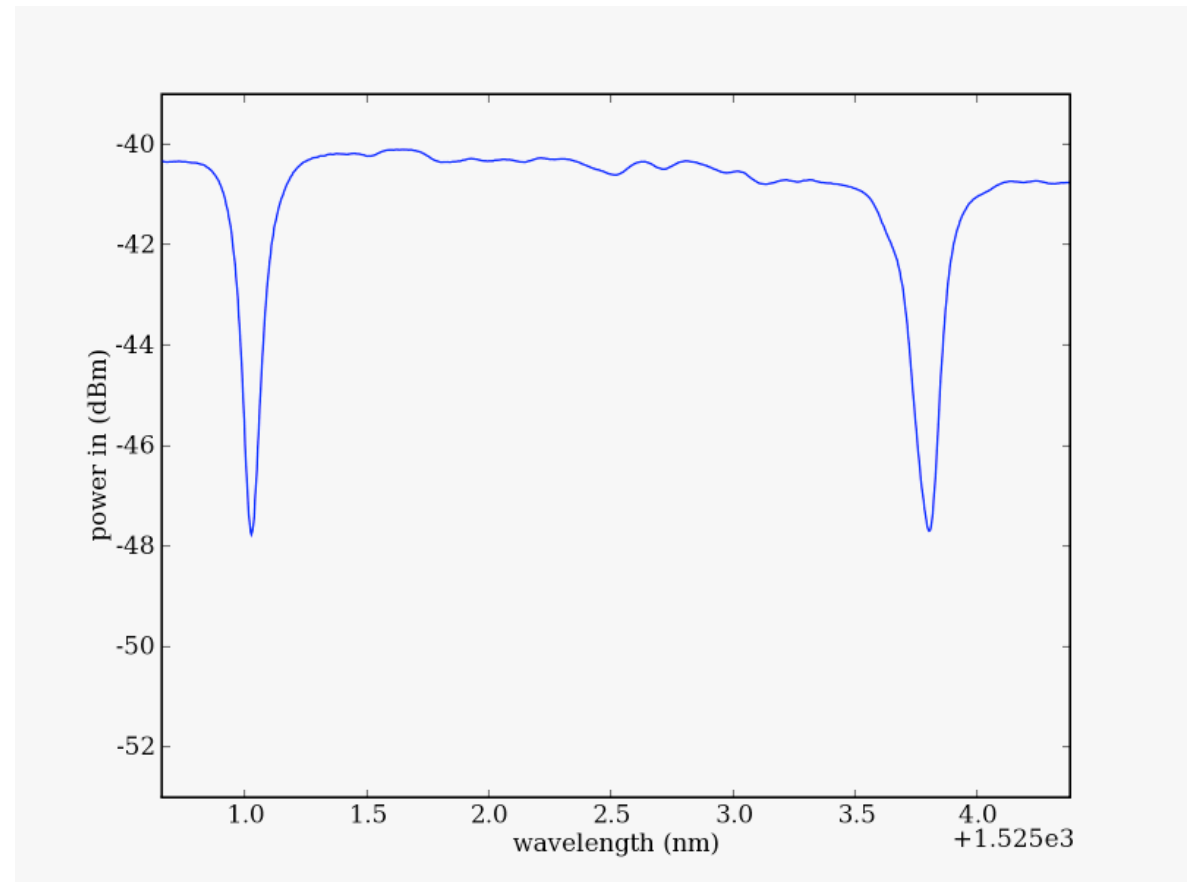
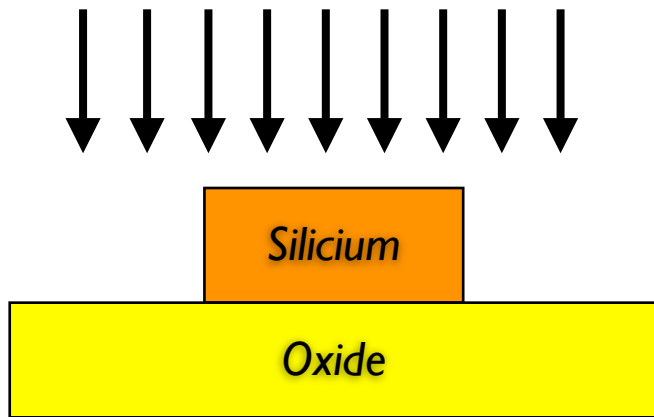

Rek in Silicium

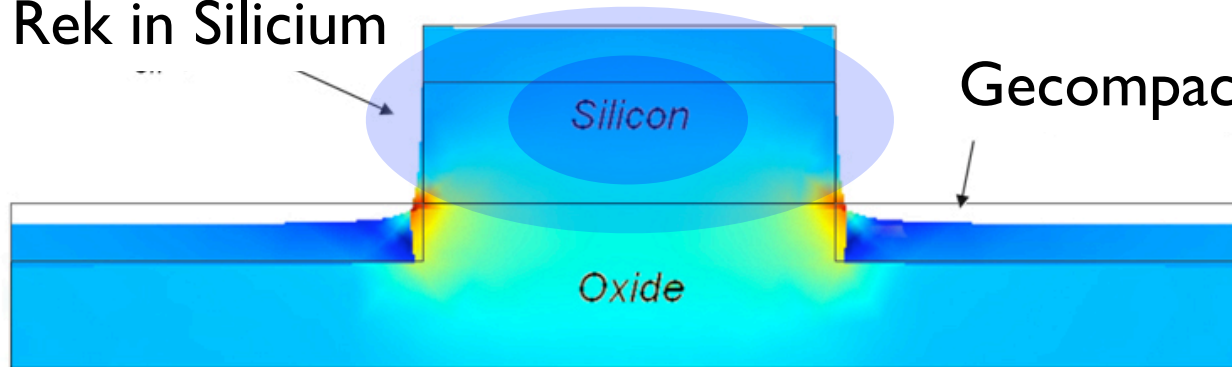

Gecompecteerd oxide



Schrauwen et al. *Optics Express*,
vol. 16(6), p.3738 (2007)



Schrauwen et al. *US Patent Pending* (2007)

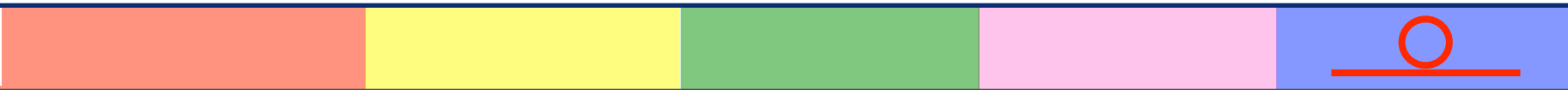

Dit doctoraat:

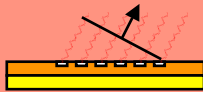
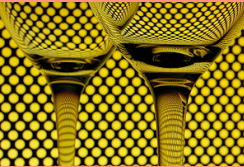

Nanofotonisch!

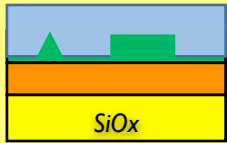
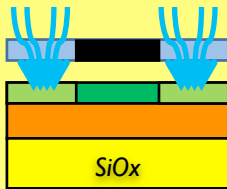

FIB:

1. flexibel = prototypes
2. precies
3. 3D structuren

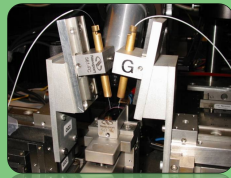

Jodium blijft plakken

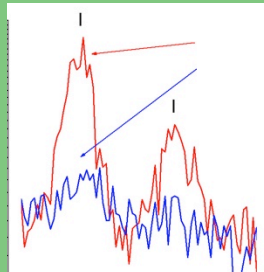

Verliezen

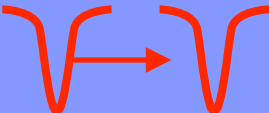
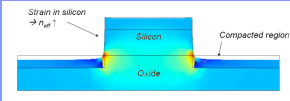
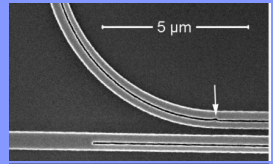
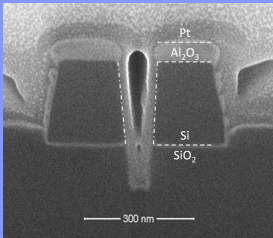
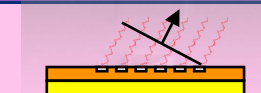
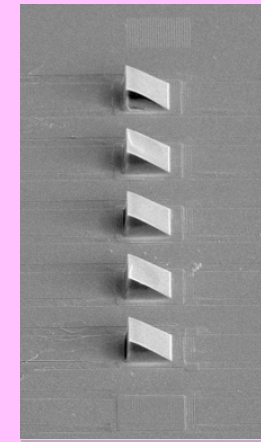
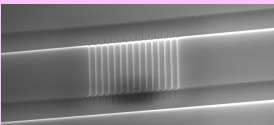
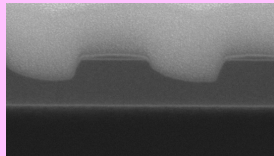



Fabricage van nanofotonische structuren met gefocusseerde ionenbundels

publieke verdediging
Jonathan Schrauwen

Promotor: Prof. Dries Van Thourhout

Vakgroep Informatietechnologie
Faculteit Ingenieurswetenschappen

4 februari 2009





Ringresonatoren zijn filters

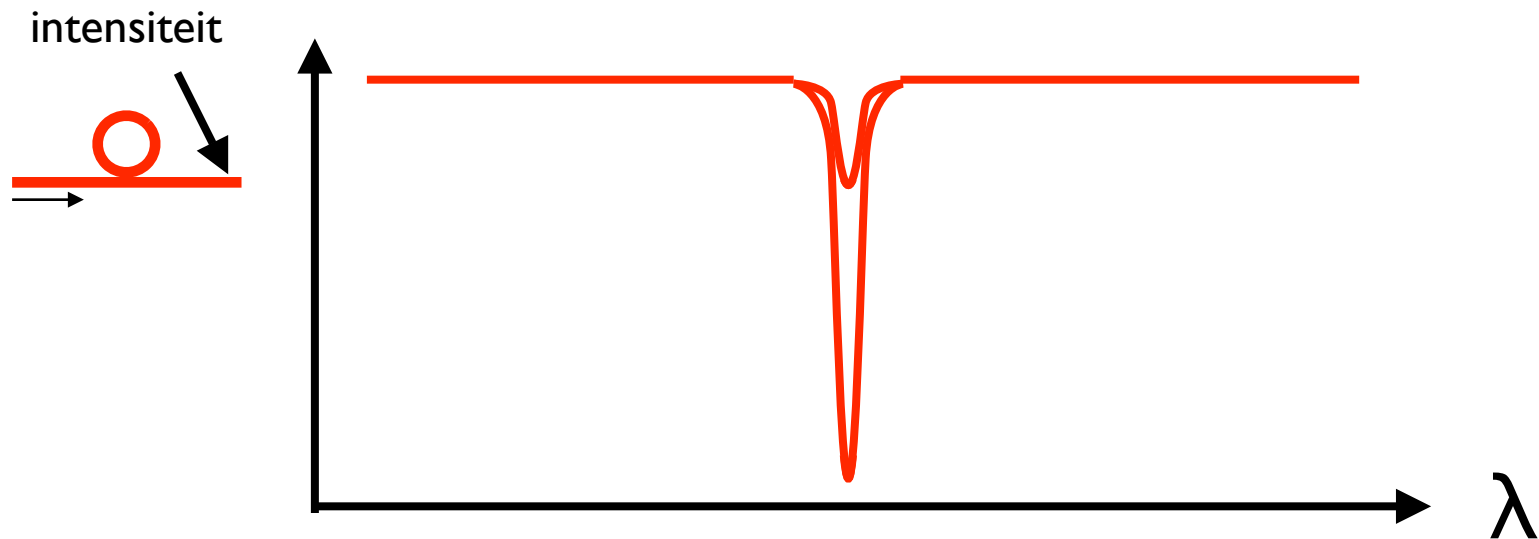
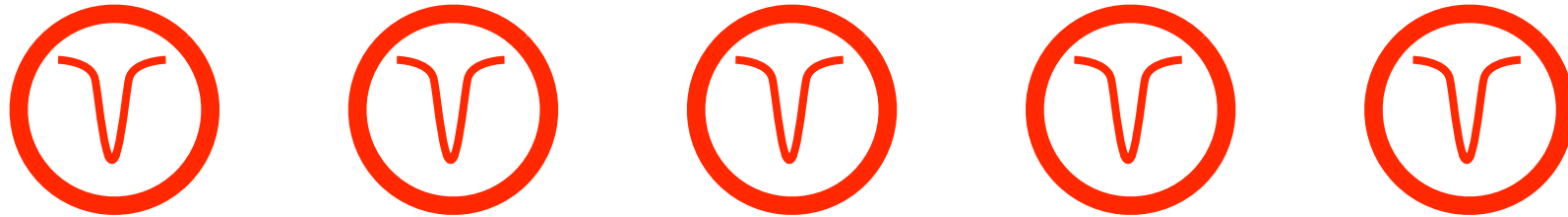

Het internet

